

# NOISE FILTER

1Ø 250V 경제형 DIN Rail & Terminal Type

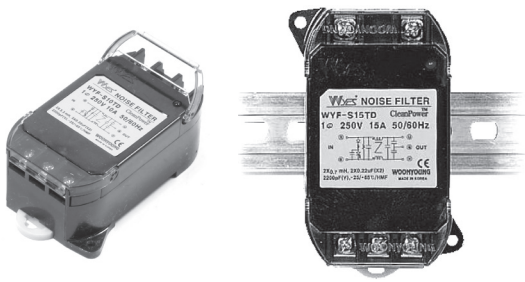

### ● Features

- 2 Mounting : Din Rail & Screw
- Wide Band : High Attenuation
- Band Width : 150KHz~30MHz
- Low Leakage
- Low Cost
- RoHS Compliant

### ● Specifications

ITEM	MODEL	SYMBOL	WYFS06TD	WYFS10TD	WYFS15TD	WYFS20TD
Rated Voltage	V		250			
Rated Current	A		6	10	15	20
Frequency	Hz		50/60			
Dielectric Withstand	V		2000Vac for 1 minute or 1075Vdc for 1 minute			
Insulation Resistance	MΩ		300			
Leakage Current	mA		≤2.5mA at the 250Vac			
Operating Temperature	°C		-25°C ~ +100°C [Refer to Derating Curve TYPE-1]			
Operating Humidity	RH		35~85%RH			
Weight	kg		0.1			

※ Derating Curve of page 103

### ● Circuit Diagram

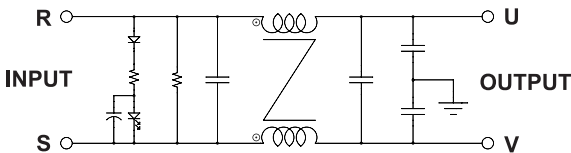

### ● Terminal

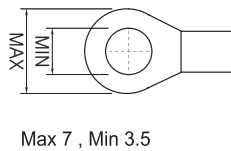

### ● Characteristics

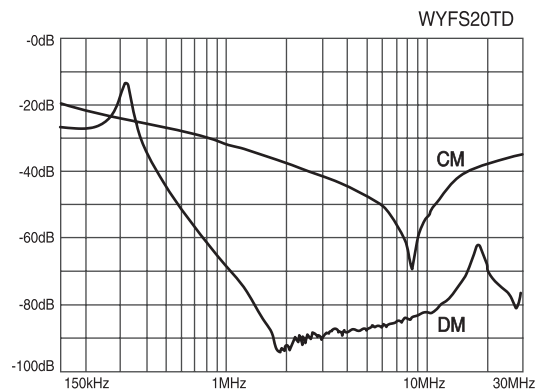
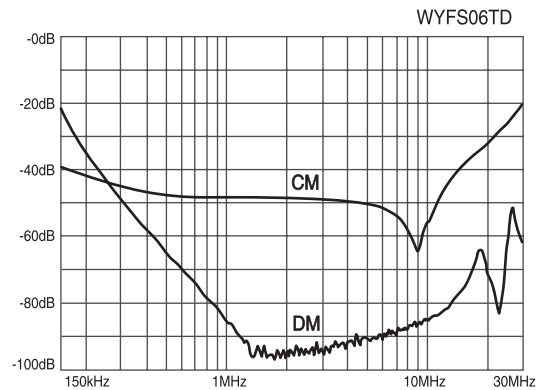

### ● Dimension

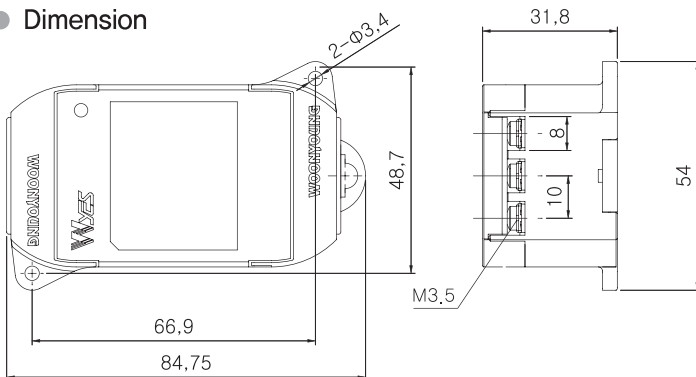

트랜스포머  
REACTOR  
리액터  
무정전압 레이어  
SSR  
스위칭 파워  
노이즈 필터  
H/F  
하모닉 필터  
SPD  
서지 보호기  
RELAY  
보통계전기  
ELD=GF  
누전경보기  
ZCT  
영상변류기  
METER  
판넬메타  
CT=VT  
계기용 변성기  
SHUNT=FA  
선트팬

● Characteristics

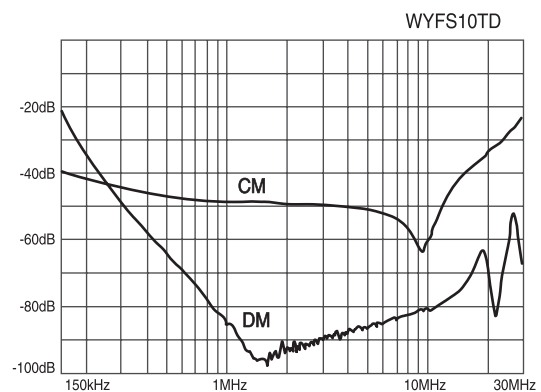
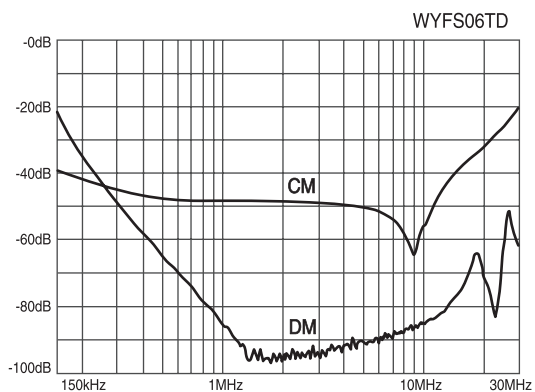
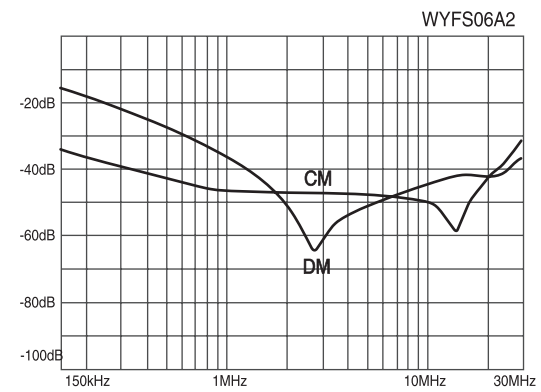
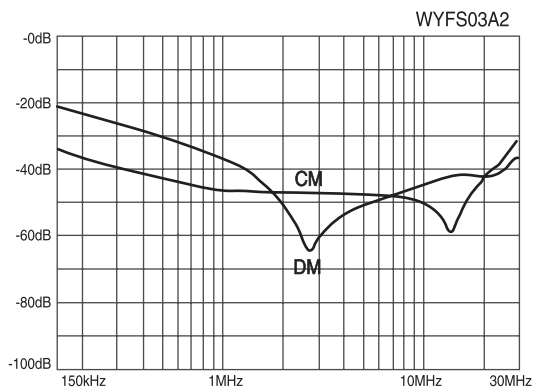
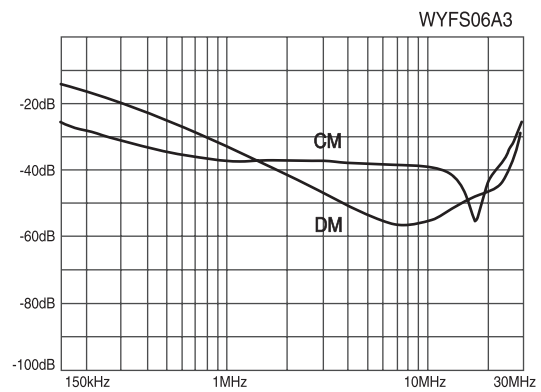
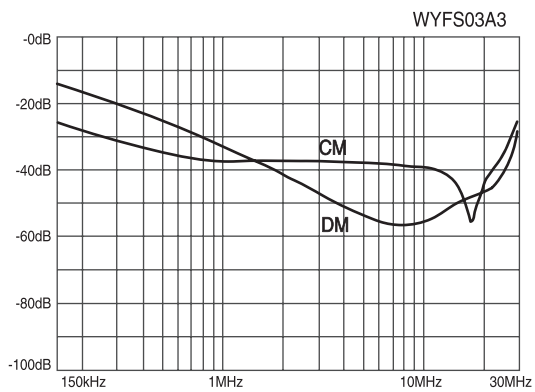
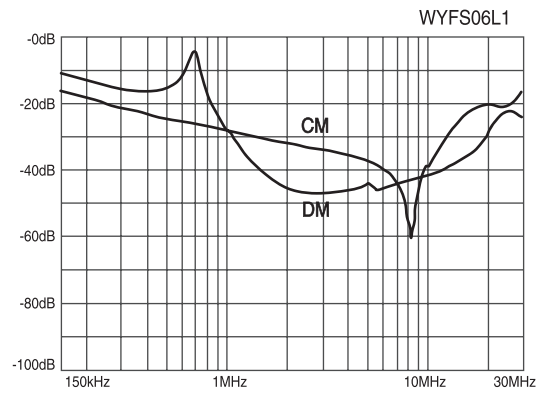
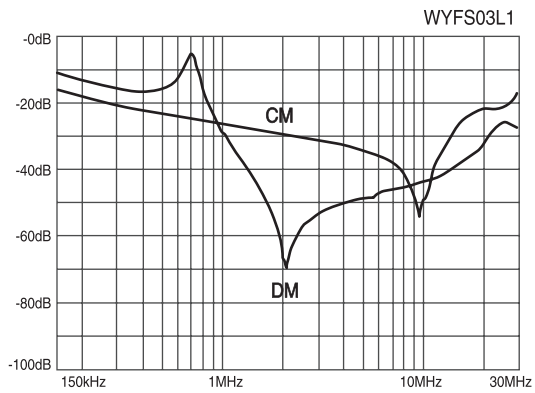

※ CM : Common mode, DM : Differential mode

● Characteristics

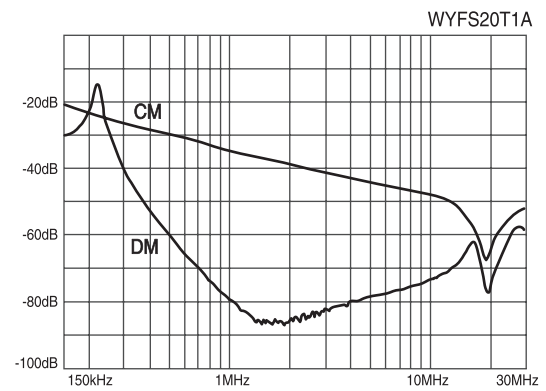
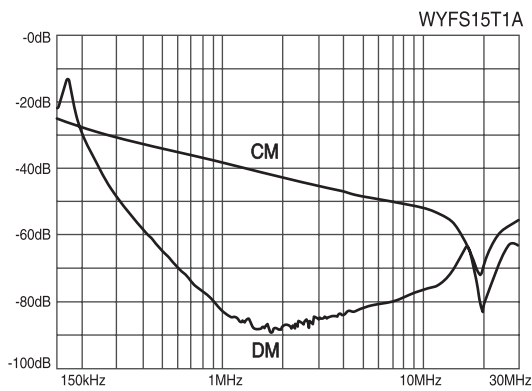
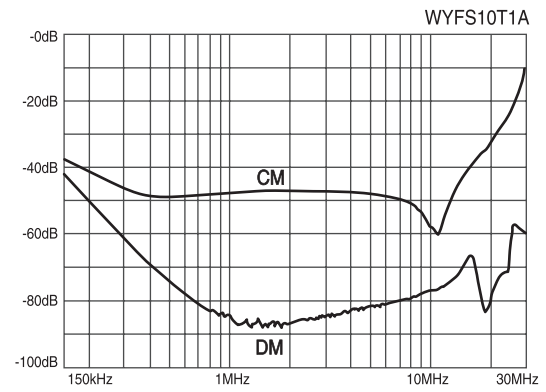
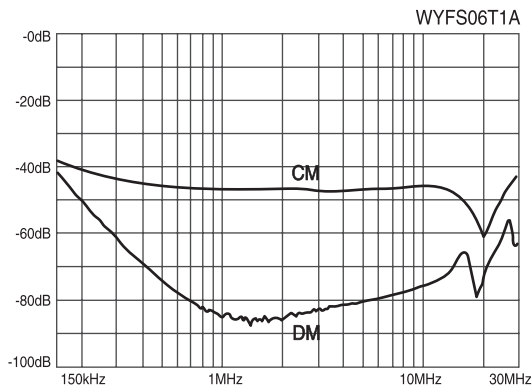
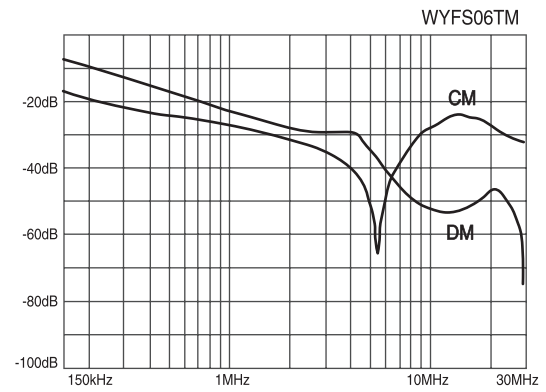
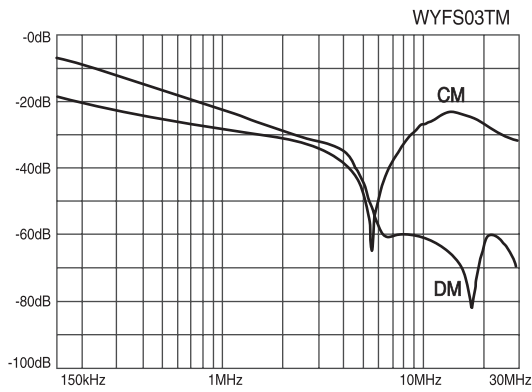
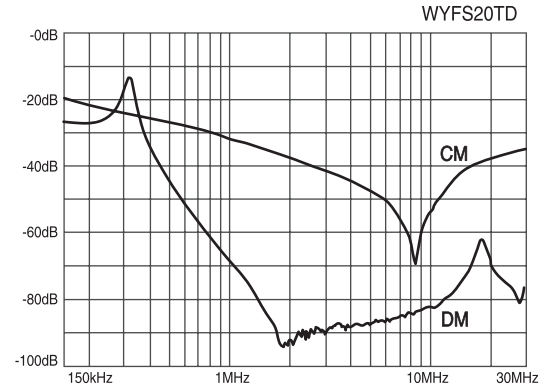
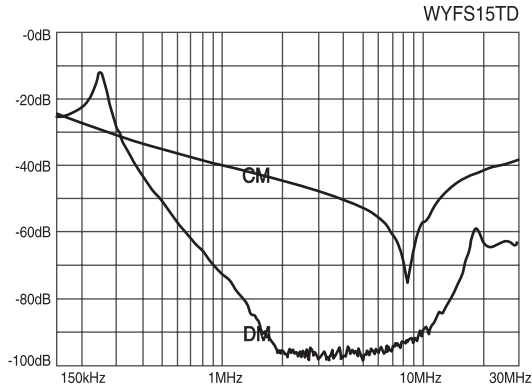

※ CM : Common mode, DM : Differential mode

트랜스포머  
REACTOR  
리액터  
무전선블레이  
SSR  
전력조정기  
TPR  
스입형파워  
SMP  
노이즈필터  
N/F  
하모닉필터  
H/F  
서지보호기  
SPD  
보호계전기  
RELAY  
누전경보기  
ELD=GF  
R  
영상변류기  
ZCT  
판넬메타  
METER  
계기용변성기  
CT=VT  
SHUNT=FA  
선트팬