



### ● Features

- 2 Mounting Option
  - WYF\*\*\*\*D : Din Rail Mounting
  - WYF\*\*\*\* : Screw Mounting
- Wide Band : High Attenuation
- Band Width : 150KHz ~ 30MHz
- Low Leakage
- RoHS Compliant
- KC(안전인증)
- Approved by HH03009-10002C

### ● Specifications

ITEM	MODEL	SYMBOL	WYFT05T1B (D)	WYFT10T1B (D)	WYFT15T1B (D)	WYFT20T1B (D)	WYFT30T1B (D)
Rated Voltage	V		250				
Rated Current	A		5	10	15	20	30
Frequency	Hz		50 / 60				
Dielectric Withstand	V		2500VAC for 1 minute (Line-Case)				
Insulation Resistance	M $\Omega$		500				
Leakage Current	mA		0.8				
Operating Temperature	°C		-25°C ~ +100°C [Refer to Derating Curve TYPE-2]				
Operating Humidity	RH		35 ~ 85%RH				
Weight	kg		0.5				

※ "D" : DIN-Rail type of page 184 / Derating Curve of page 103

### ● Circuit Diagram

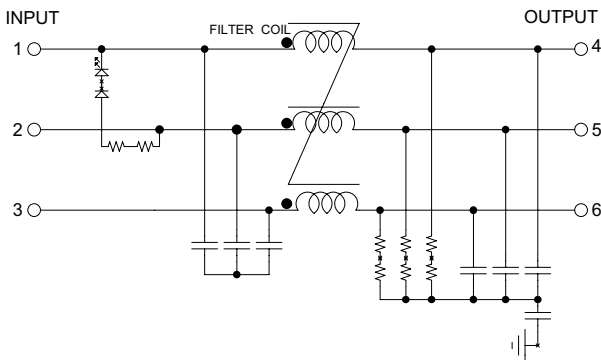

### ● Terminal

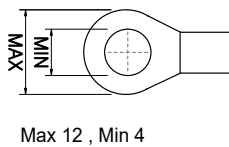

### ● Characteristics

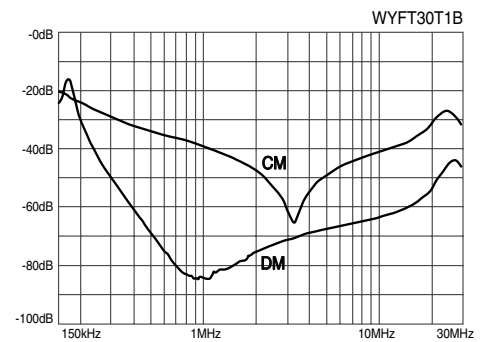
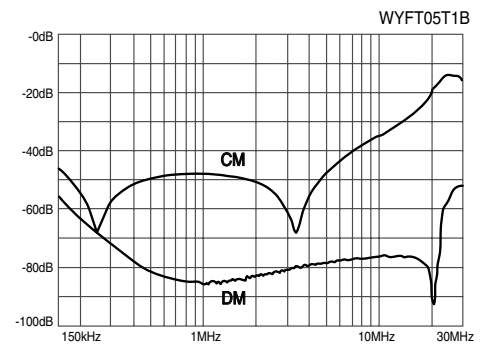

### ● Dimension

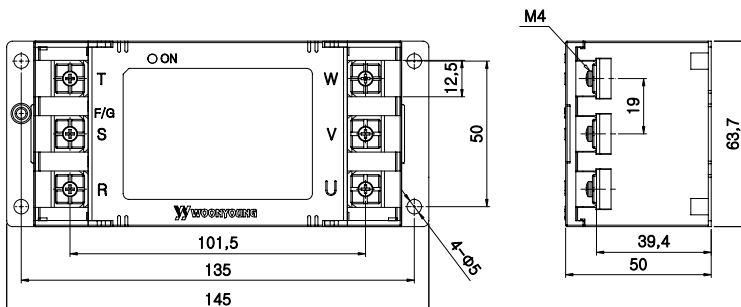

● Characteristics

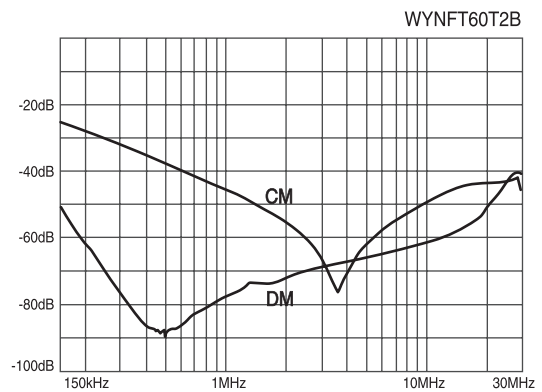
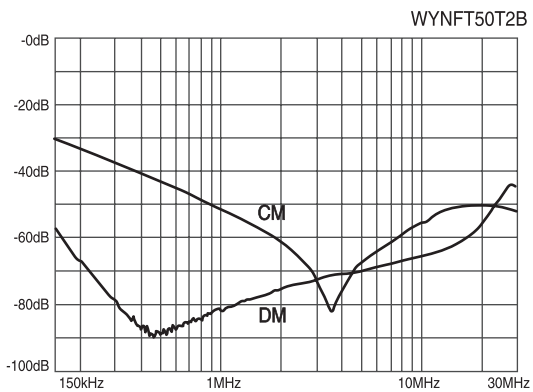
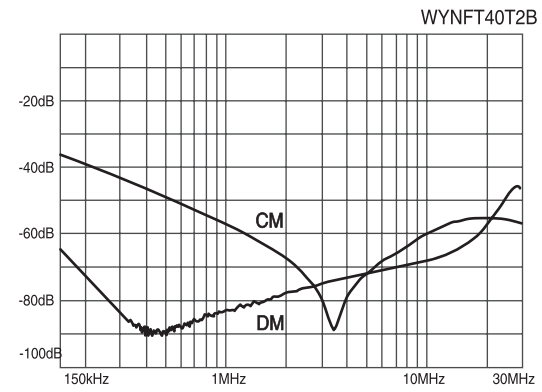
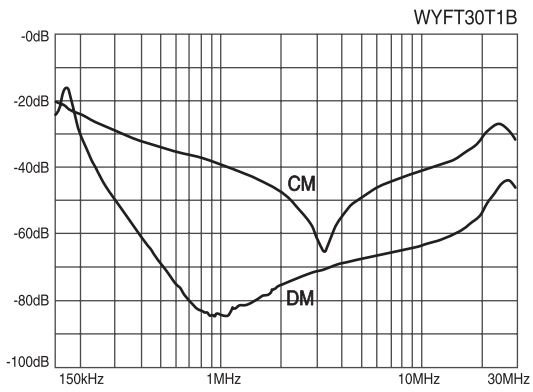
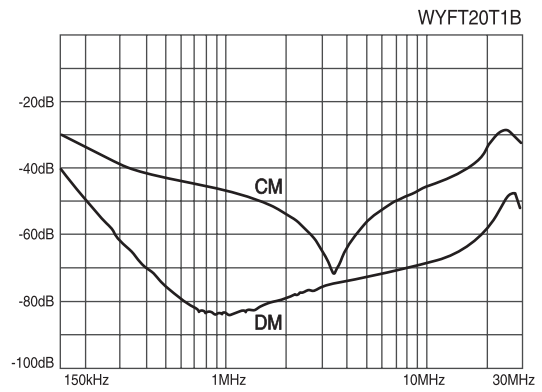
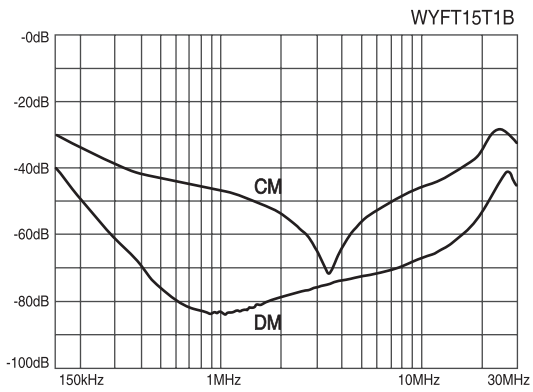
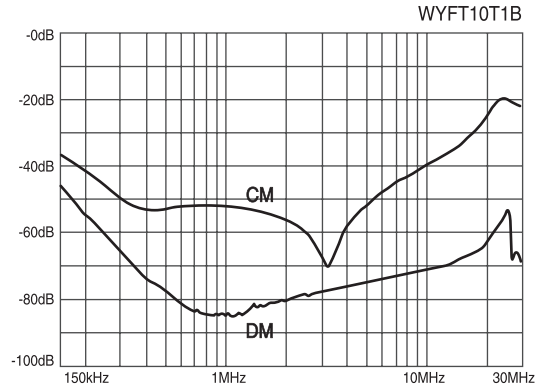
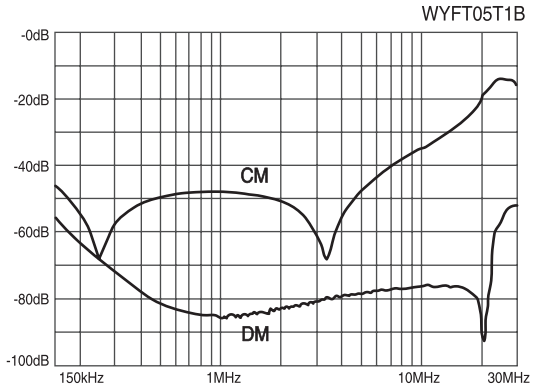

※ CM : Common mode, DM : Differential mode