



### ● Features

- 2 Mounting Option
  - WYF\*\*\*\*D : Din Rail Mounting
  - WYF\*\*\*\* : Screw Mounting
- Wide Band : High Attenuation
- Band Width : 150KHz ~ 30MHz
- Low Leakage
- RoHS Compliant
- KC(안전인증) Approved by HH03009-15004A
- Inverter Output Type : Model Type"C" (WYFT05T1C)

### ● Specifications

ITEM	MODEL	SYMBOL	WYFT05T1A(D)	WYFT10T1A(D)	WYFT15T1A(D)	WYFT20T1A(D)	WYFT30T1A(D)
			WYFT05T1C(D)	WYFT10T1C(D)	WYFT15T1C(D)	WYFT20T1C(D)	WYFT30T1C(D)
Rated Voltage	V		250				
Rated Current	A		5	10	15	20	30
Frequency	Hz		50 / 60				
Dielectric Withstand	V		2500VAC for 1 minute (Line-Case)				
Insulation Resistance	M $\Omega$		500				
Leakage Current	mA		$\leq 2.5$ mA at the 250Vac				
Operating Temperature	$^{\circ}$ C		-25 $^{\circ}$ C ~ +100 $^{\circ}$ C [Refer to Derating Curve TYPE-2]				
Operating Humidity	RH		35 ~ 85%RH				
Weight	kg		0.5				

※ Derating Curve of page 519

### ● Circuit Diagram

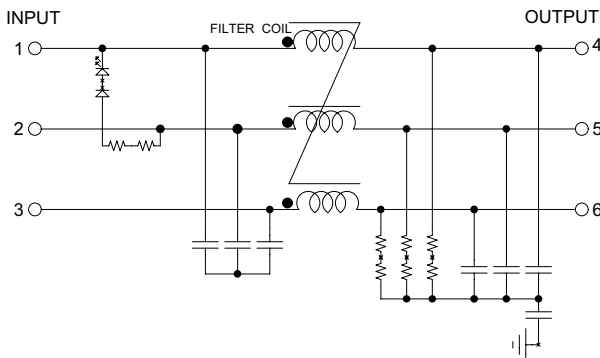

### ● Terminal

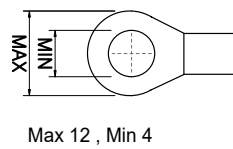

### ● Characteristics

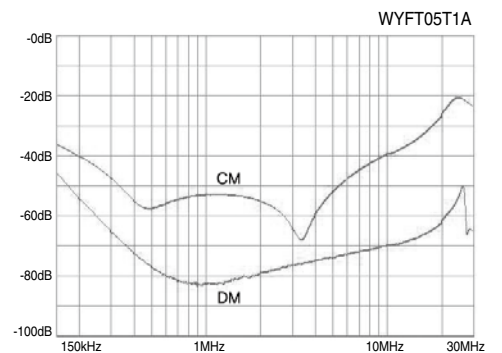

### ● Dimension

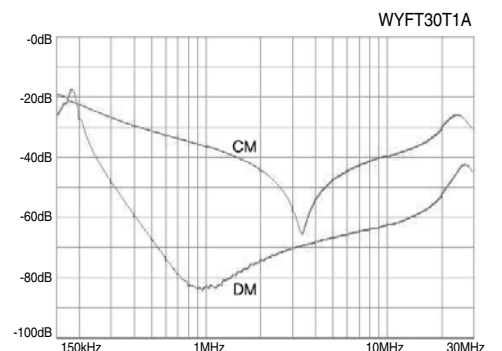
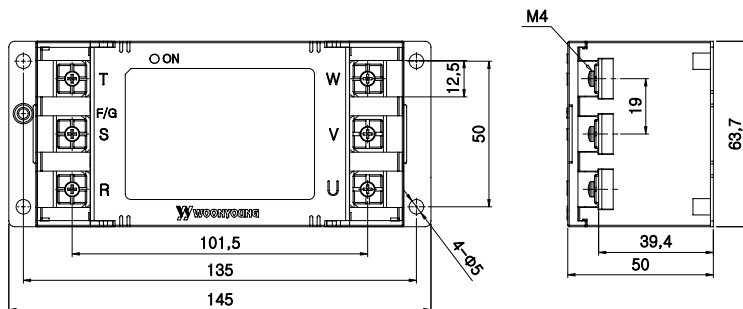

● Characteristics

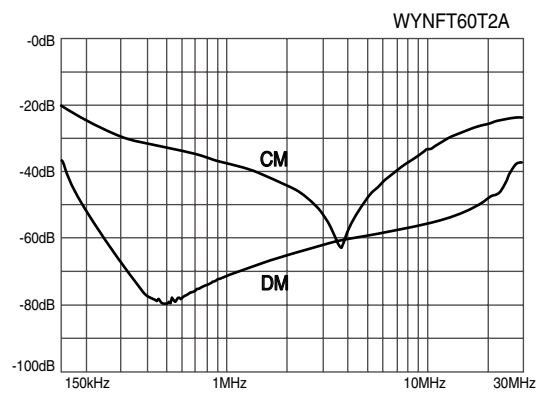
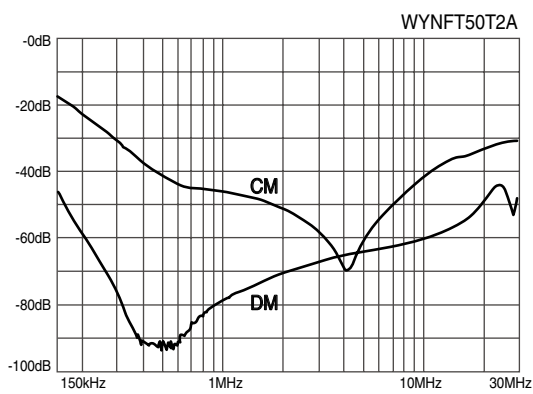
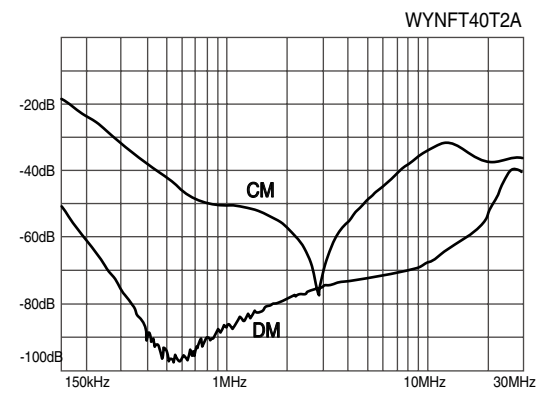
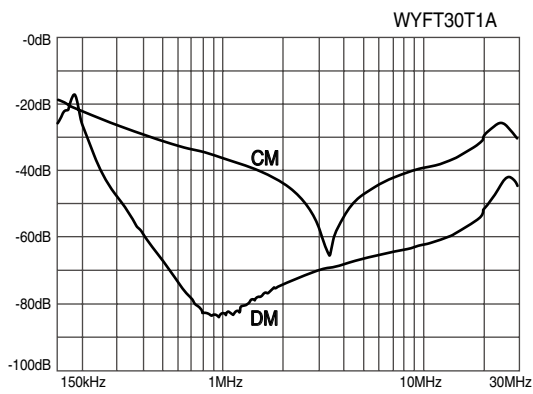
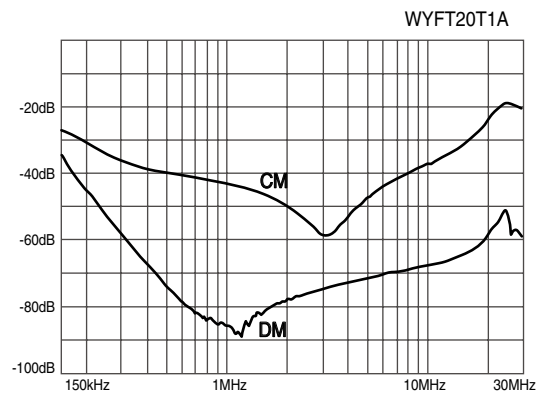
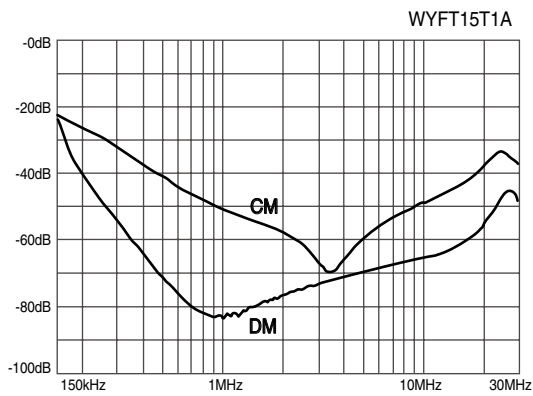
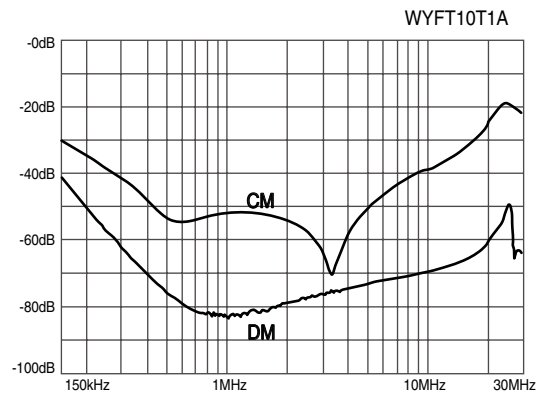
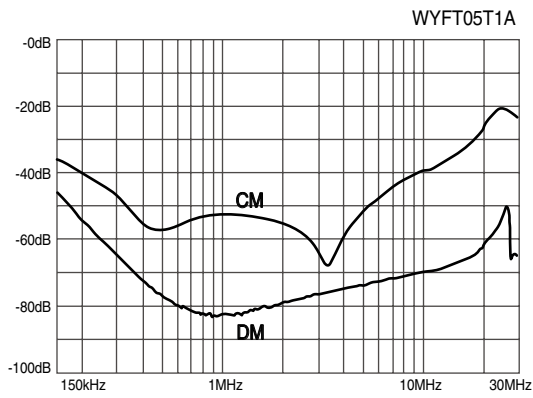

※ CM : Common mode, DM : Differential mode

### ● Characteristics

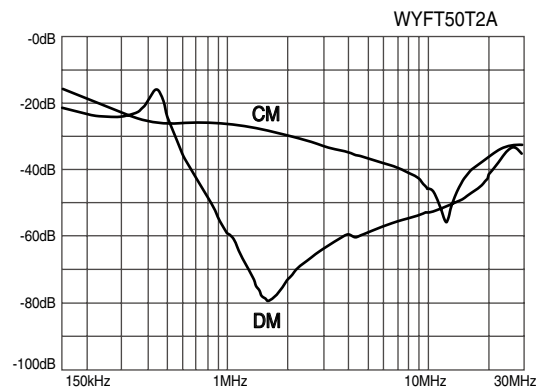
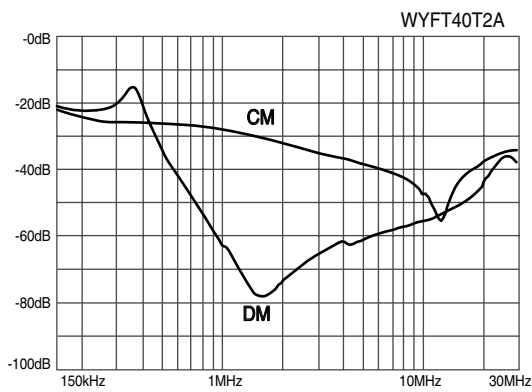
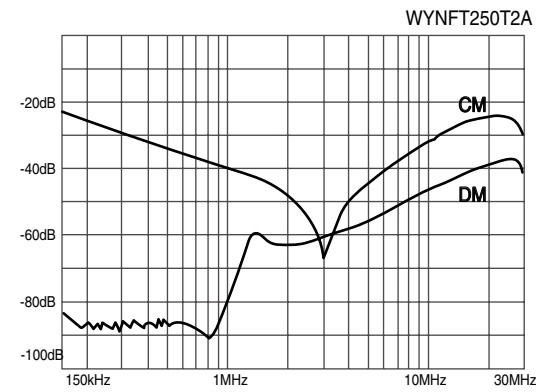
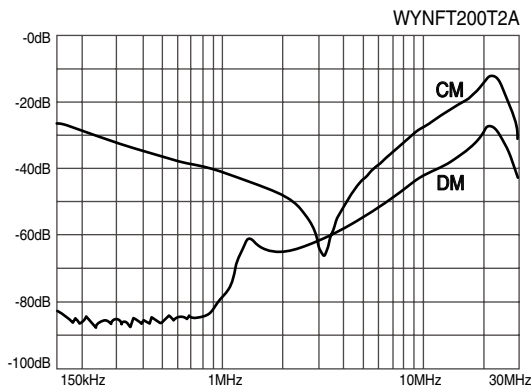
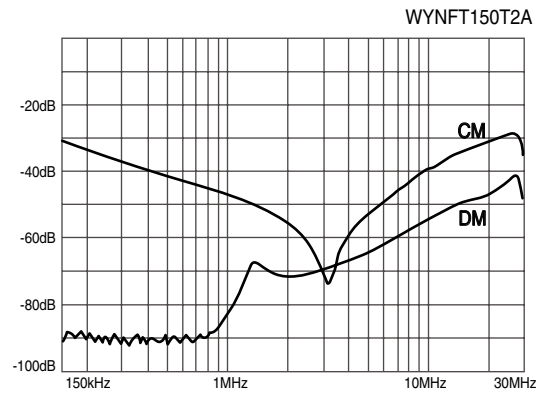
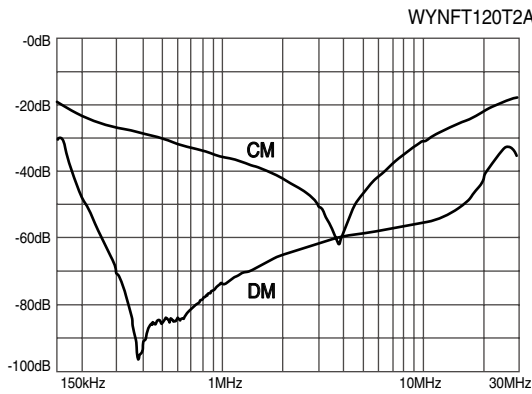
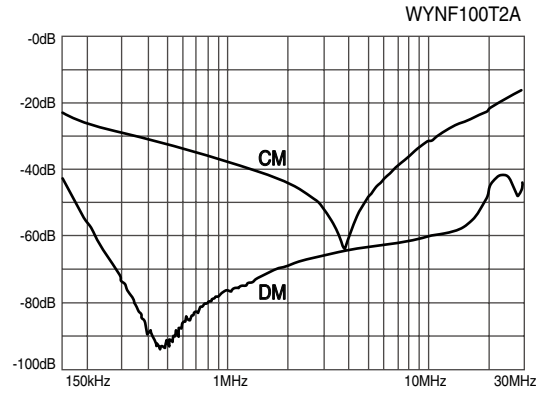
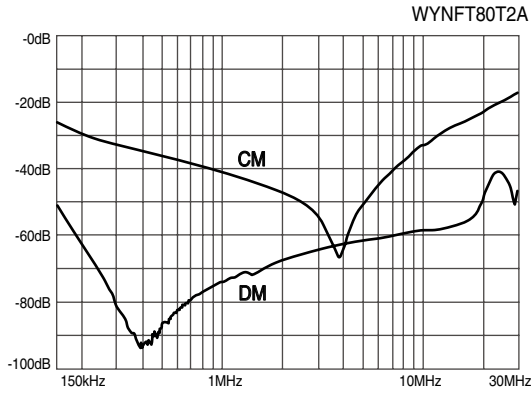

※ CM : Common mode, DM : Differential mode

트랜스포머  
REACTOR  
리액터  
무정전압블레이  
SSR  
전력조정기  
TPR  
스위칭파워  
SMPs  
노이즈 필터  
N/F  
하모닉 필터  
H/F  
서지보호기  
SPD  
보호계전기  
RELAY  
누전경보기  
ELD=GFRR  
영상변류기  
ZCT  
판넬메타  
METER  
계기용변성기  
CT=VT  
선트랜  
SHUNT=FAN

● Characteristics

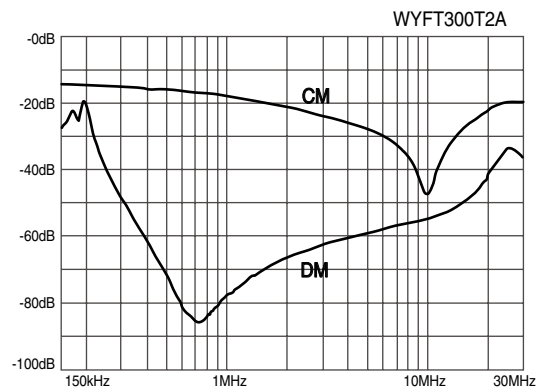
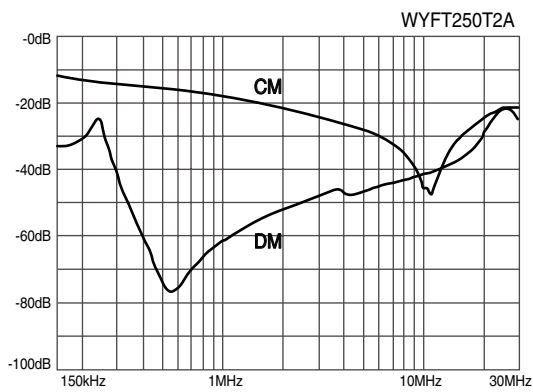
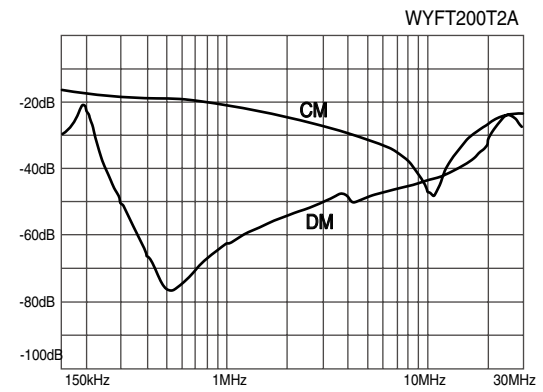
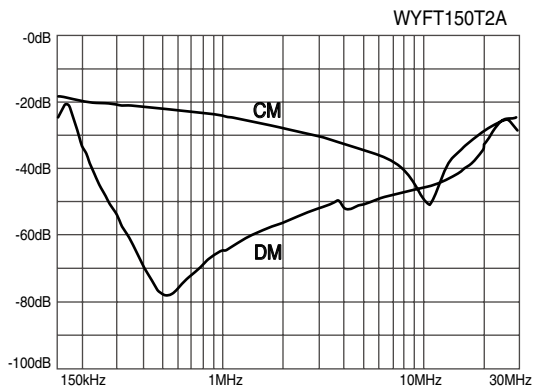
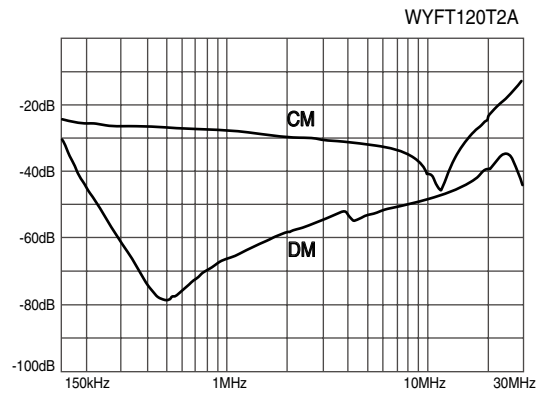
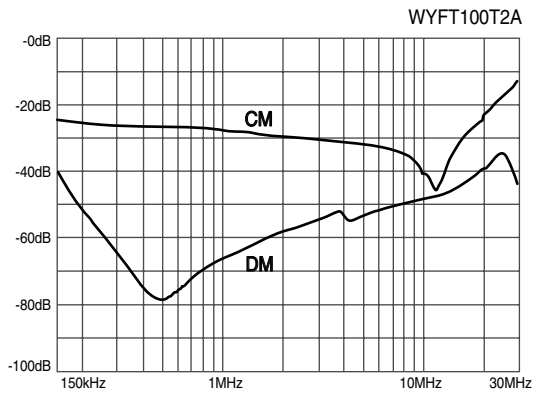
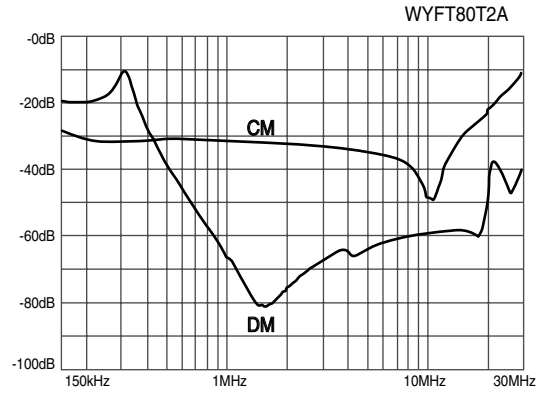
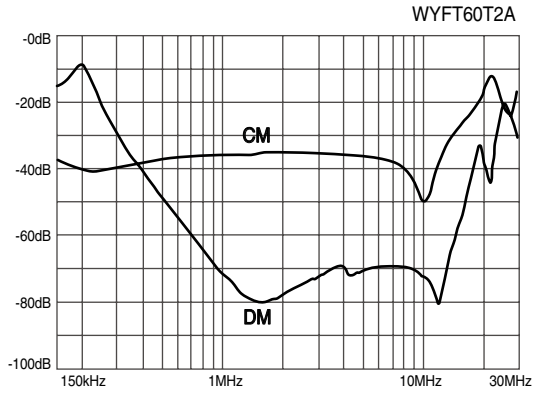

※ CM : Common mode, DM : Differential mode

### ● Characteristics

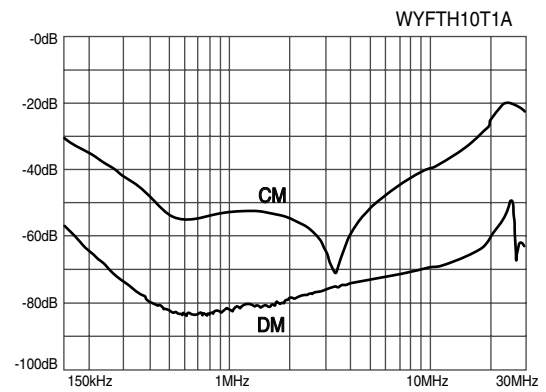
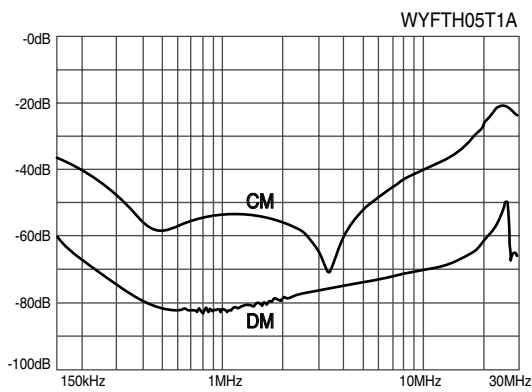
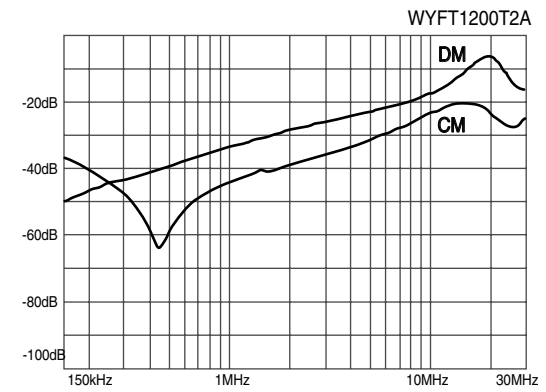
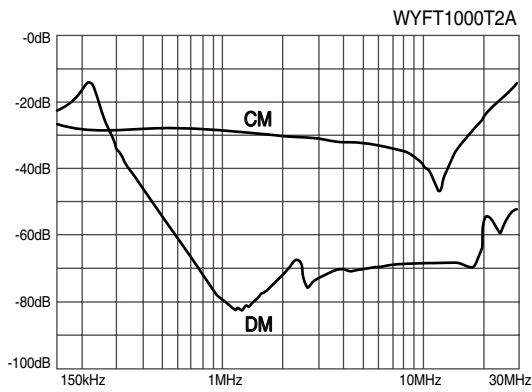
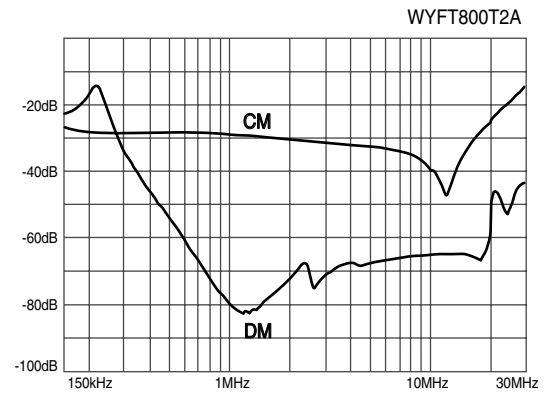
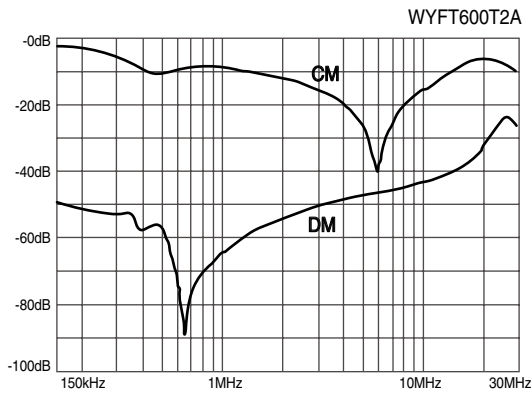
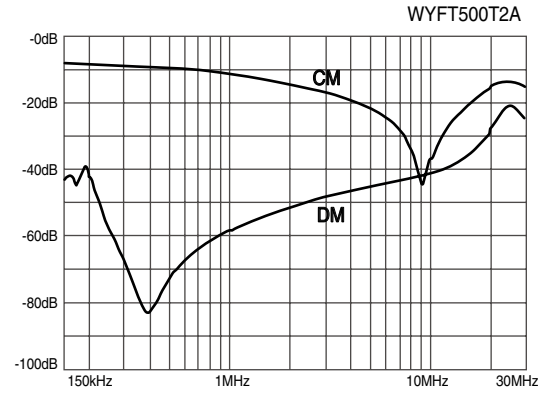
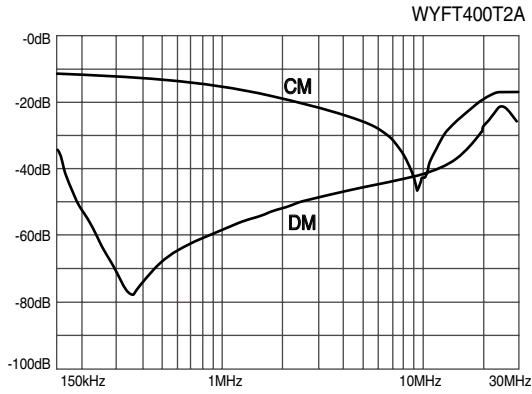

※ CM : Common mode, DM : Differential mode

트랜스포머  
REACTOR  
리액터  
무정전압 레일  
SSR  
전력조정기  
TPR  
스위칭파워  
SMP  
노이즈 필터  
H/F  
하모닉 필터  
서지보호기  
SPD  
보호계전기  
RELAY  
누전경보기  
ELD=GF  
R  
영상변류기  
ZCT  
판넬메타  
METER  
계기용변성기  
CT=VT  
SHUNT=FA  
N

## 30 250V Characteristics

### ● Characteristics

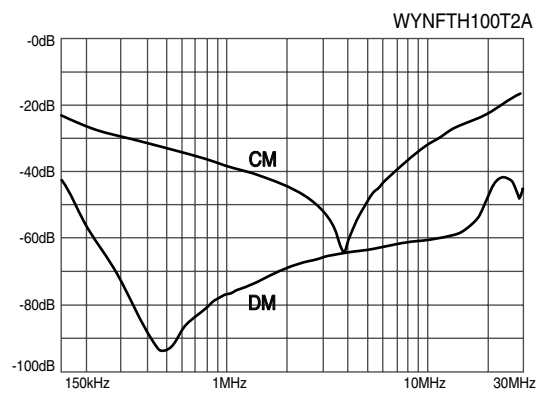
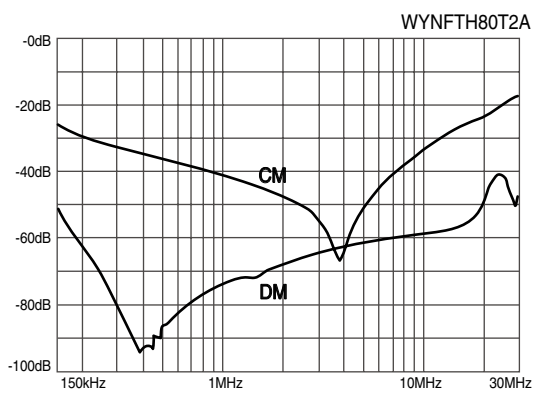
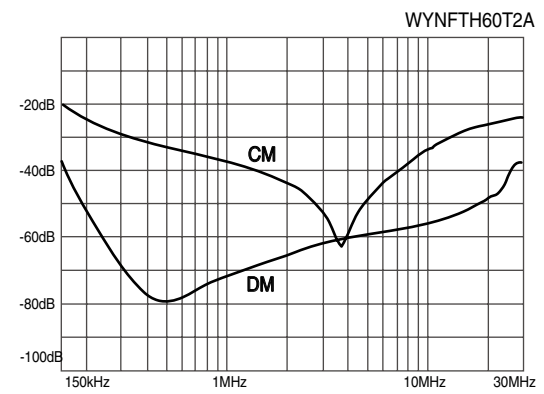
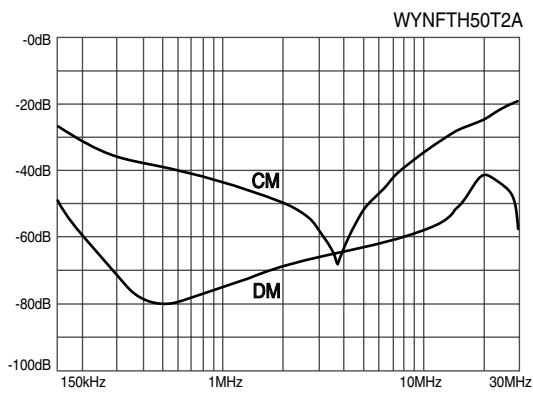
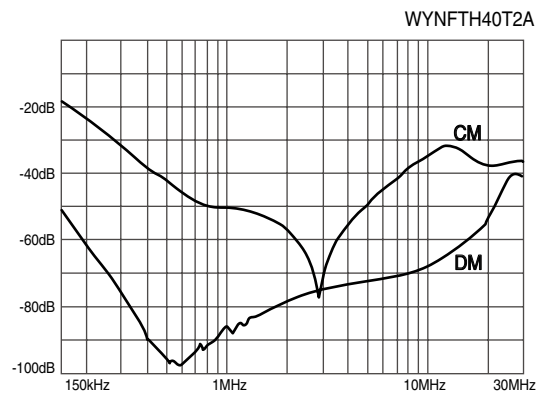
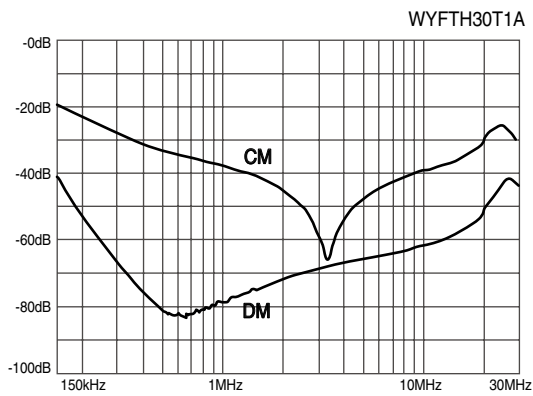
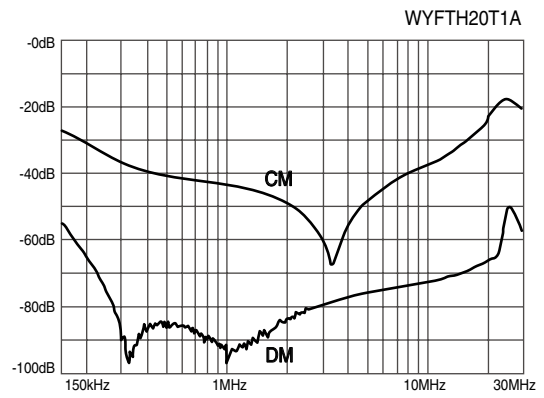
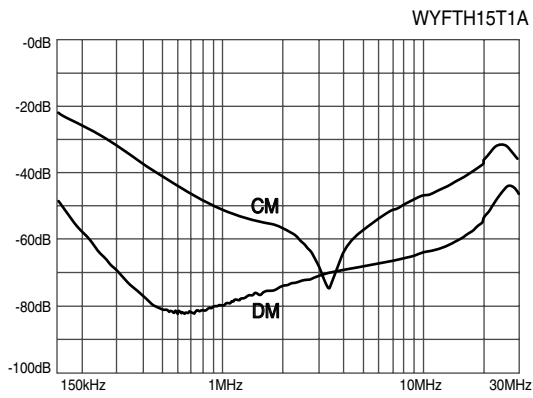

※ CM : Common mode, DM : Differential mode

### ● Characteristics

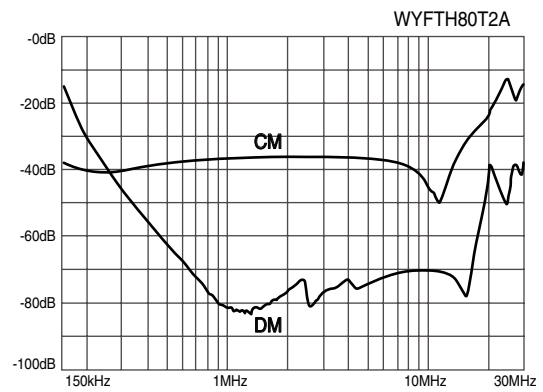
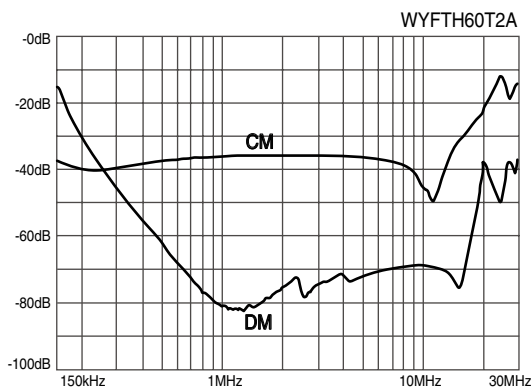
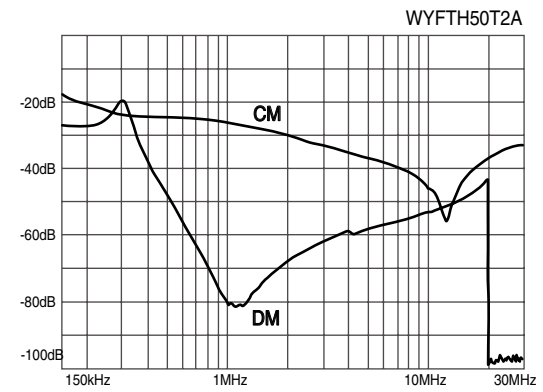
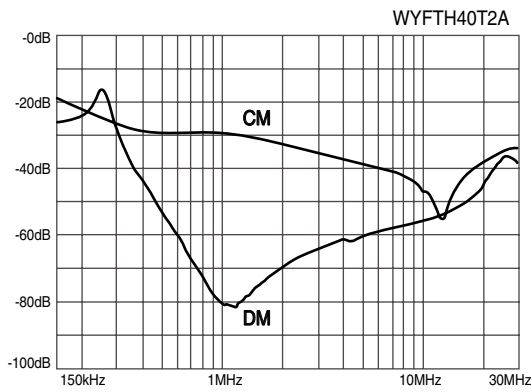
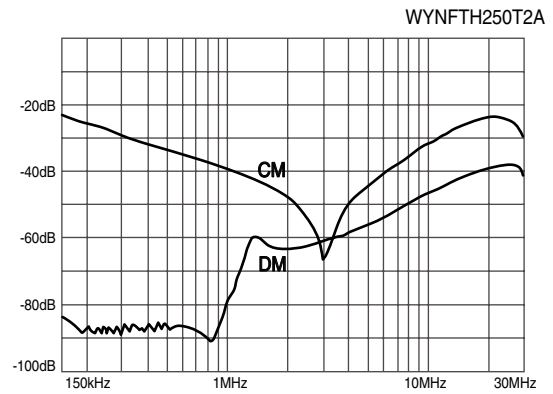
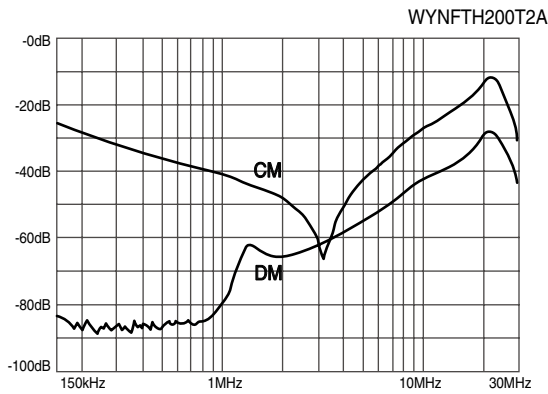
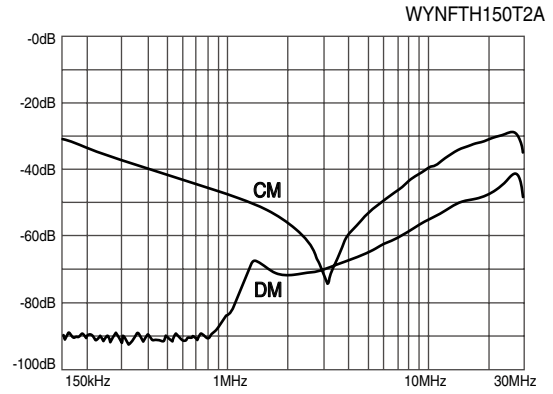
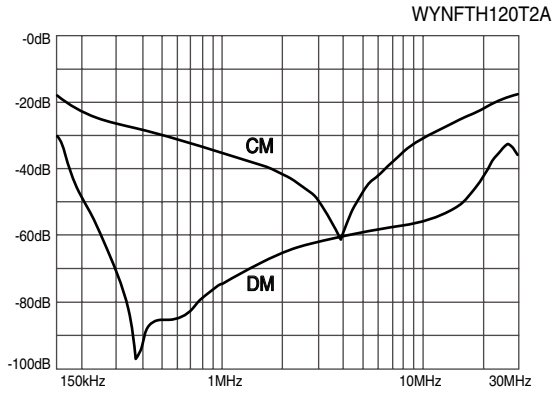

※ CM : Common mode, DM : Differential mode

트랜스포머  
REACTOR  
리액터  
무정전압블레이  
SSR  
전력조정기  
TPR  
스위칭파워  
SMP  
노이즈 필터  
N/F  
하모닉 필터  
H/F  
서지보호기  
SPD  
보호계전기  
RELAY  
누전경보기  
ELD=GF  
R  
영상변류기  
ZCT  
판넬메타  
METER  
계기용변성기  
CT=VT  
SHUNT=FA  
N

● Characteristics

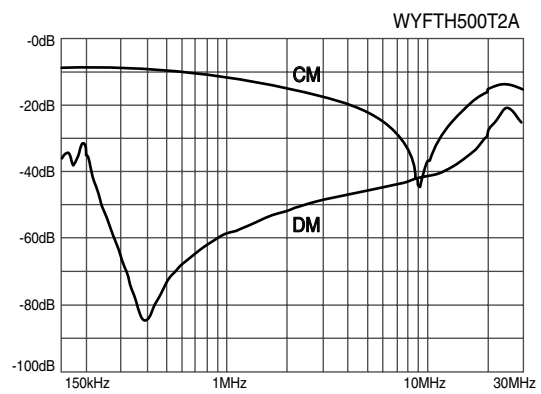
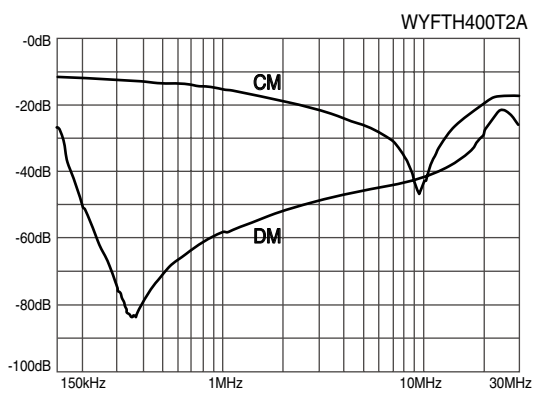
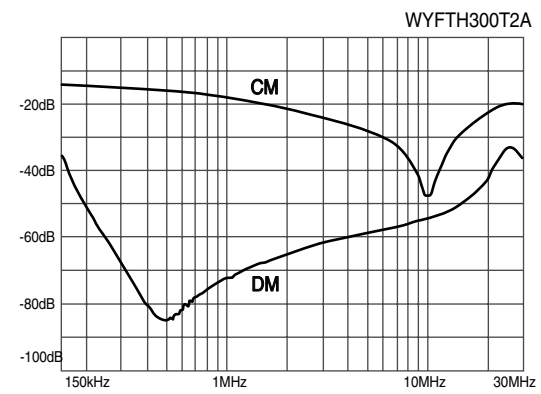
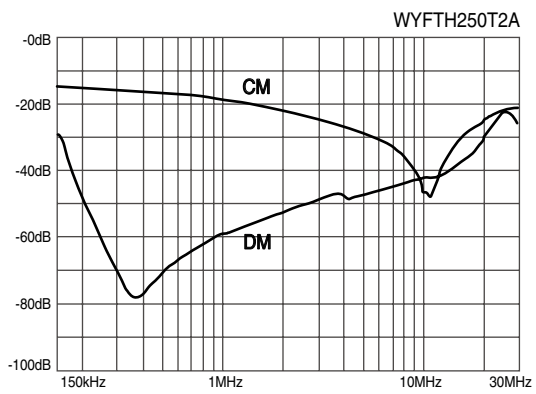
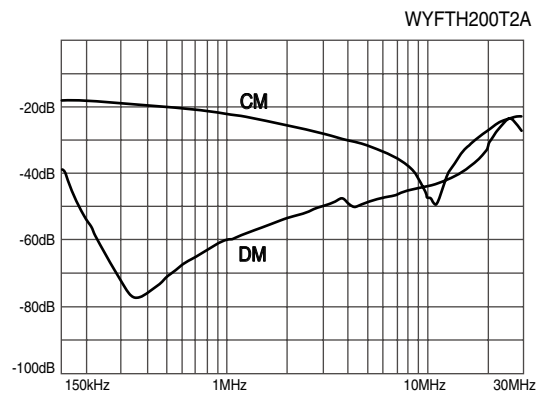
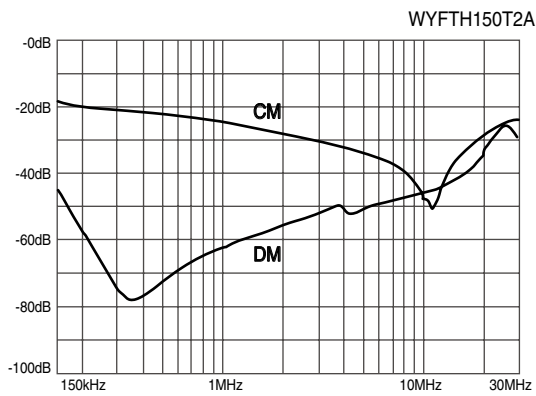
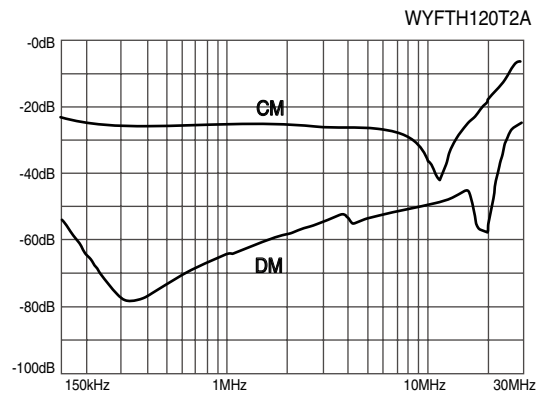
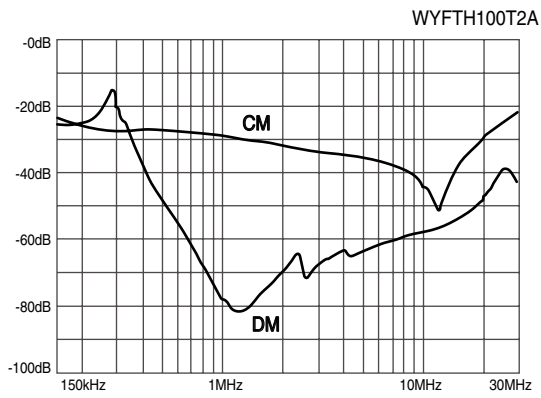

※ CM : Common mode, DM : Differential mode



### ● Characteristics

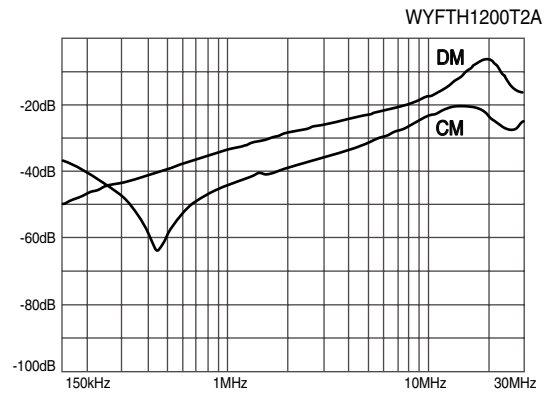
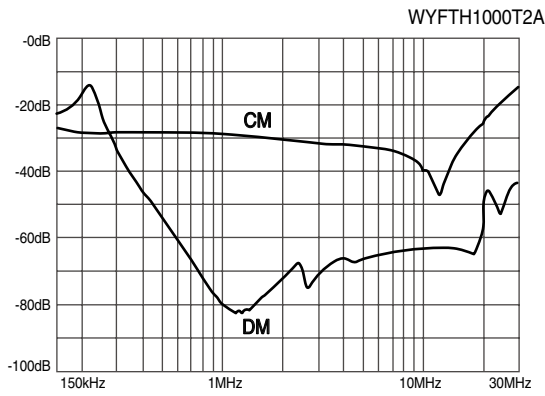
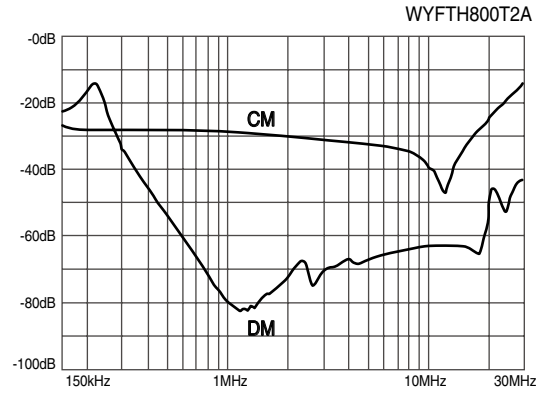
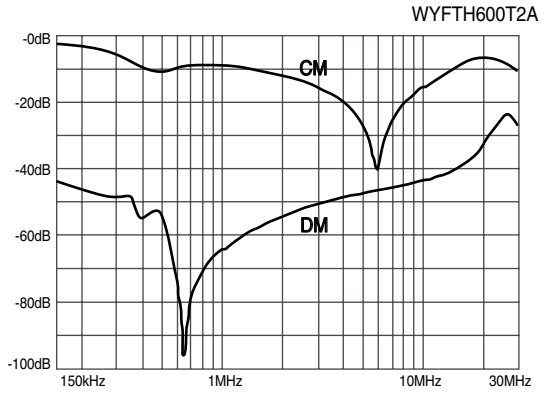

DM

※ CM : Common mode, DM : Differential mode

트랜스포머  
리액터  
무정전압 레일  
전력조정기  
스위칭파워  
노이즈 필터  
하모닉 필터  
서지보호기  
보호계전기  
영상변류기  
판넬메타  
계기용변성기  
선트랜스팬