

단상 복권형으로 AC 380V 이며 출력은 AC 110V로 10VA부터 350VA까지 규격화 하였습니다. AC 입력 전압 인가시 전원 표시 LED가 동작하여 소비자의 안전성을 고려한 제품입니다. DIN Rail 전용(Bolt 취부 겸용)으로 DIN Rail에 손쉽게 장착 할 수 있습니다.

Input voltage of single phase is AC 380V and output is AC 110V. Product is standardized from 10VA to 350VA. The AC input voltage is applied, the power indicator LED operates in consideration of the safety of the consumer. It is easily mounted on DIN Rail.

• Circuit Diagram

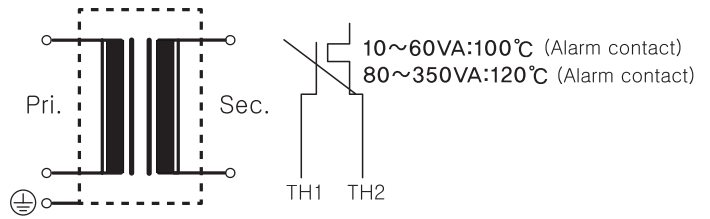

● Specifications

MODEL NO.	TYPE	SPECIFICATIONS		CAPA. (VA)	DIMENSIONS (mm)								WEIGHT (kg)
		PRI.(V)	SEC.(V)		W	H	D	a	b	c	d	M	
• 380V Line → 110V Line													
WY3811-10TD	DIN RAIL & PANEL	380-0	110-0	10	68,8	84,8	96,8	77,5	50	30	7	M3,5	0,76
WY3811-20TD				20	68,8	84,8	96,8	77,5	50	30	7	M3,5	0,76
WY3811-30TD				30	68,8	87,8	96,8	77,5	50	30	7	M3,5	0,89
WY3811-40TD				40	68,8	93,8	96,8	77,5	50	30	7	M3,5	0,76
WY3811-60TD				60	68,8	108,8	96,8	77,5	50	30	7	M3,5	0,89
WY3811-80TD				80	86,9	99,9	106	93	66	50	7	M3,5	1,80
WY3811-120TD				120	86,9	113,9	106	93	66	50	7	M3,5	2,40
WY3811-180TD				180	86,9	128,9	106	93	66	50	7	M3,5	3,00
WY3811-220TD				220	115	117,7	130	116	90,9	65	10	M4	4,00
WY3811-280TD				280	115	134,7	130	116	90,9	65	10	M4	5,00
WY3811-350TD				350	115	146,7	130	116	90,9	65	10	M4	5,60

※Others option

● Dimension

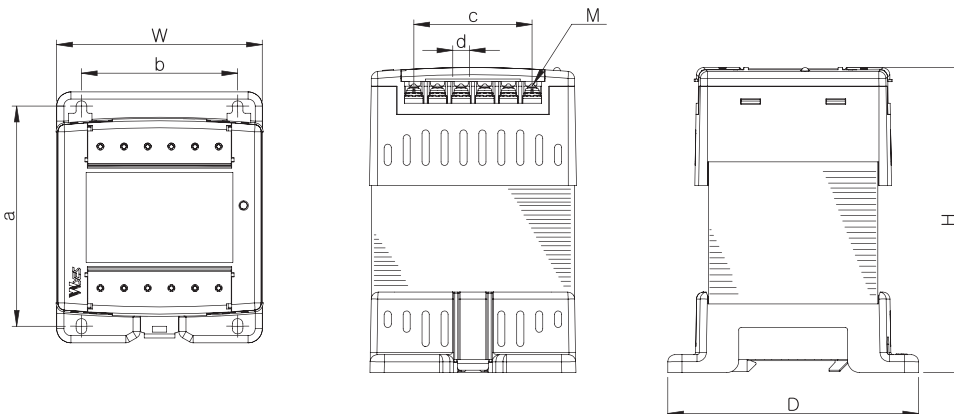

● Terminal

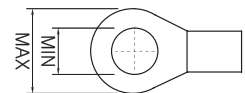

10~180VA : Max 6, Min 3.5
220~350VA : Max 9, Min 4