

NOISE FILTER

3Ø 500V 고급형 High Quality Type



● Features

- 2 Mounting Option
 - WYF****D : Din Rail Mounting
 - WYF**** : Screw Mounting
- Wide Band : High Attenuation
- Band Width : 150KHz~30MHz
- Low Leakage
- RoHS Compliant
- KC(안전인증) Approved by HK03001-19008A

● Specifications

ITEM	MODEL	SYMBOL	WYFTH05T1B (D)	WYFTH10T1B (D)	WYFTH15T1B (D)	WYFTH20T1B (D)	WYFTH30T1B (D)
Rated Voltage	V		500				
Rated Current	A		5	10	15	20	30
Frequency	Hz		50/60				
Dielectric Withstand	V		2500Vac for 1 minute or 2150Vdc for 1 minute				
Insulation Resistance	MΩ		500				
Leakage Current	mA		1,2				
Operating Temperature	°C		-25°C ~ +100°C [Refer to Derating Curve TYPE-2]				
Operating Humidity	RH		35~85%RH				
Weight	kg		0.5				

※ "D" : DIN-Rail type of page 184 / Derating Curve of page 103

● Circuit Diagram

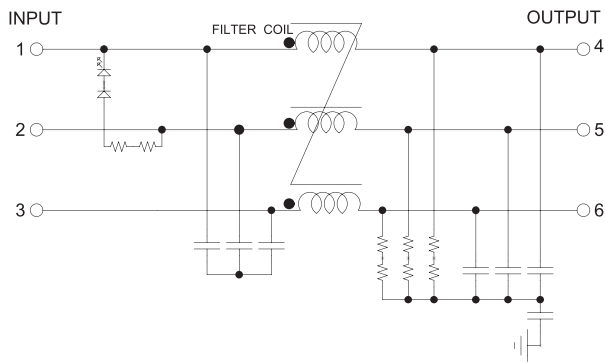

● Terminal

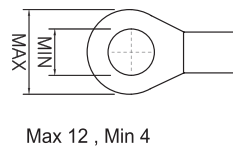

● Characteristics

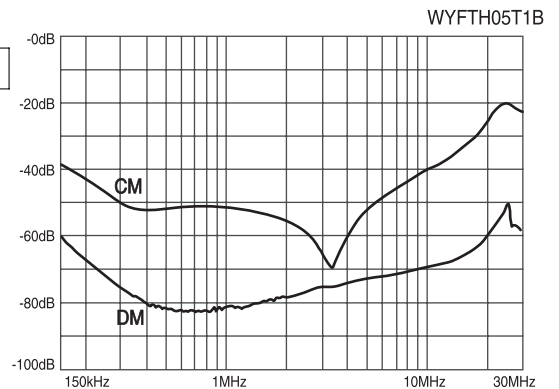

● Dimension

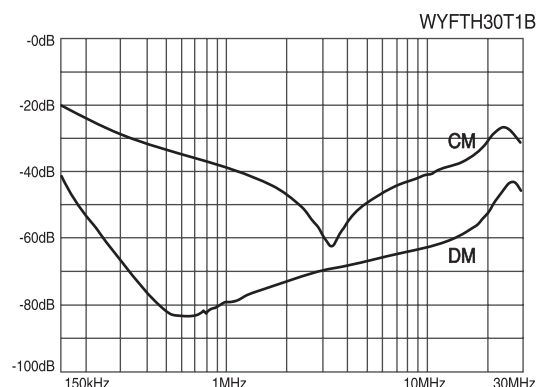
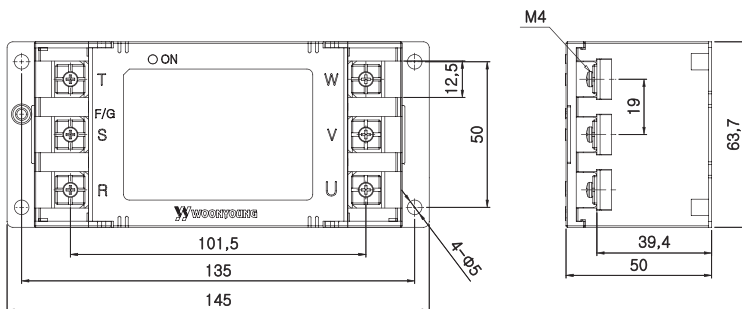

트랜스포머
REACTOR
리액터
무정전압용 레이어
SSR
전력조정기
TPR
스위칭용 파워
SMP
노이즈 필터
N/F
하모닉 필터
H/F
서지보호기
SPD
보호계전기
RELAY
누전경보기
ELD=GF
영상변류기
ZCT
판넬메타
METER
계기용 변성기
CT=VT
SHUNT=FA
선트판

● Characteristics

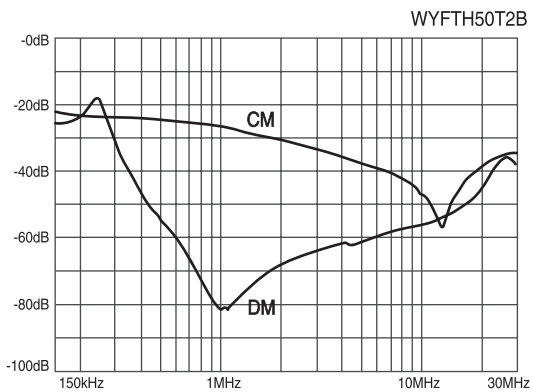
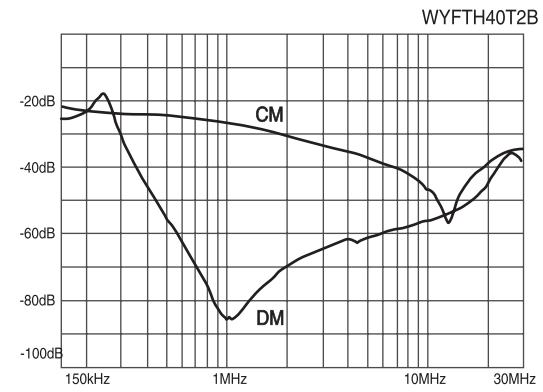
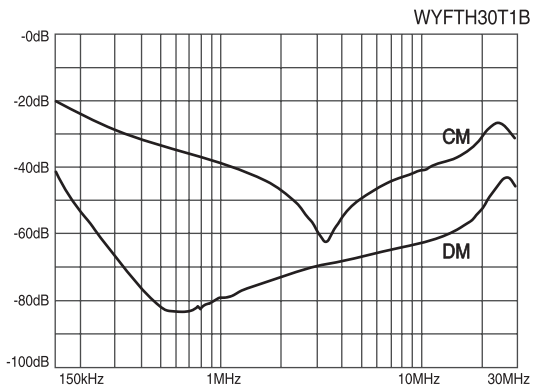
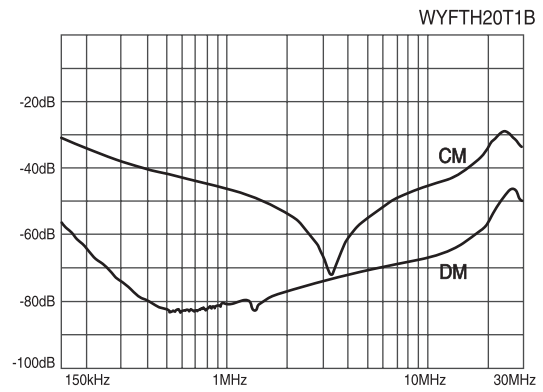
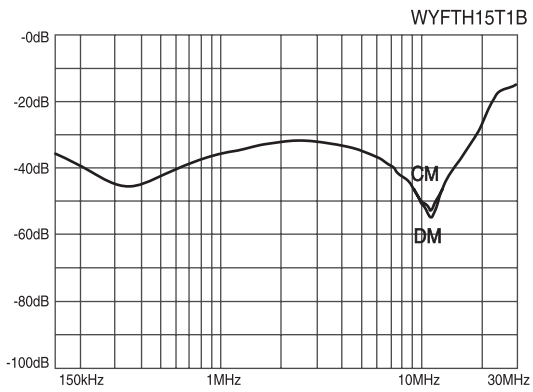
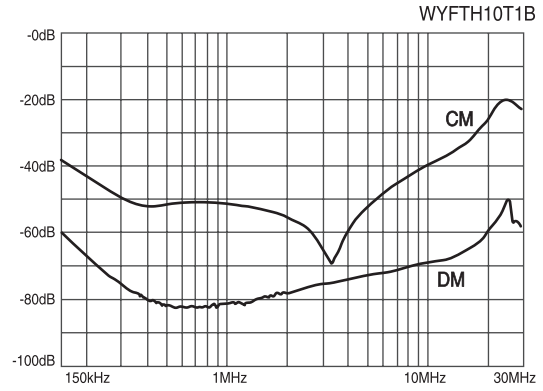
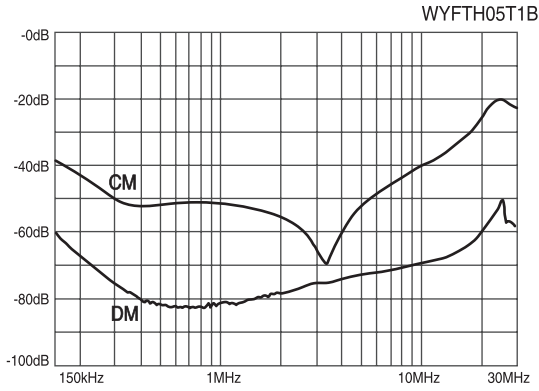

※ CM : Common mode, DM : Differential mode