

● Features

- 2 Mounting Option
 - WYF****D : Din Rail Mounting
 - WYF**** : Screw Mounting
- Wide Band : High Attenuation
- Band Width : 150KHz~30MHz
- Low Leakage
- RoHS Compliant
- KC(안전인증)
- Approved by HH03009-10002C

● Specifications

ITEM	MODEL	SYMBOL	WYFT05T1B (D)	WYFT10T1B (D)	WYFT15T1B (D)	WYFT20T1B (D)	WYFT30T1B (D)
Rated Voltage	V		250				
Rated Current	A		5	10	15	20	30
Frequency	Hz		50/60				
Dielectric Withstand	V		2000Vac for 1 minute or 1075Vdc for 1 minute				
Insulation Resistance	MΩ		500				
Leakage Current	mA		0,8				
Operating Temperature	°C		-25°C ~ +100°C [Refer to Derating Curve TYPE-2]				
Operating Humidity	RH		35~85%RH				
Weight	kg		0,5				

※ "D" : DIN-Rail type of page 184 / Derating Curve of page 103

● Circuit Diagram

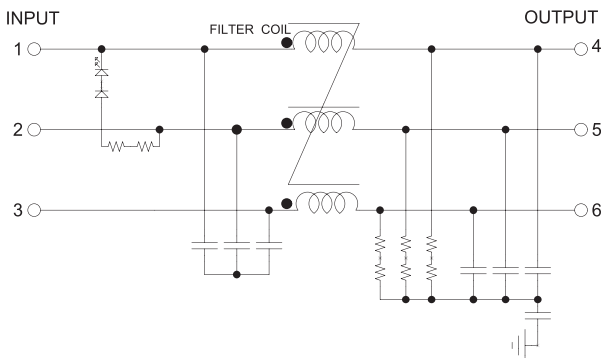

● Terminal

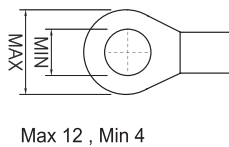

● Characteristics

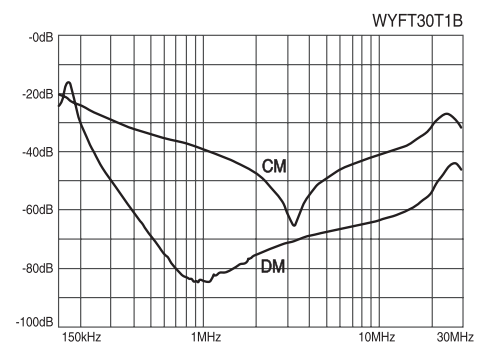
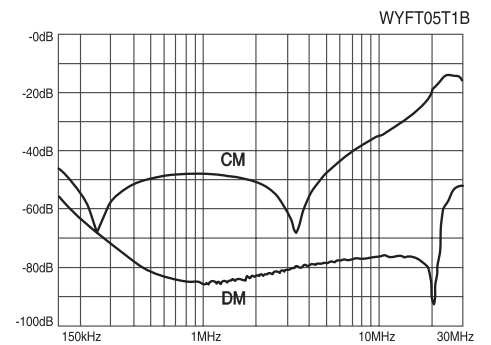

● Dimension

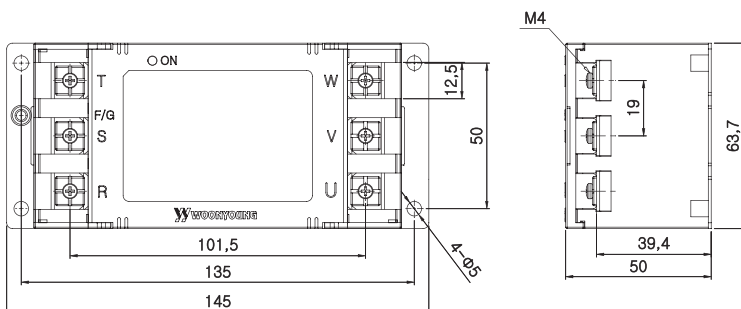

● Characteristics

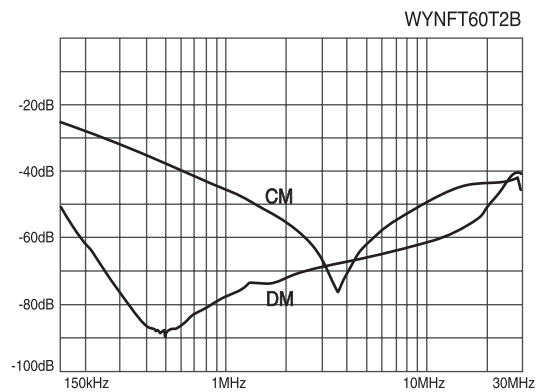
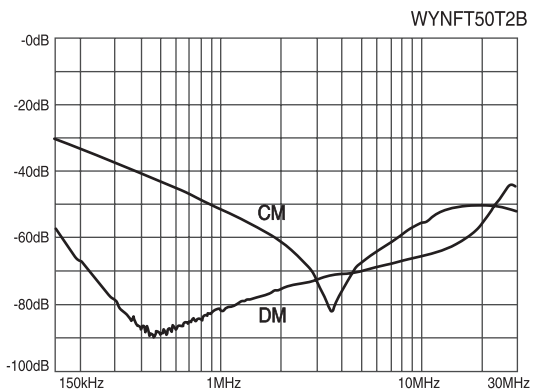
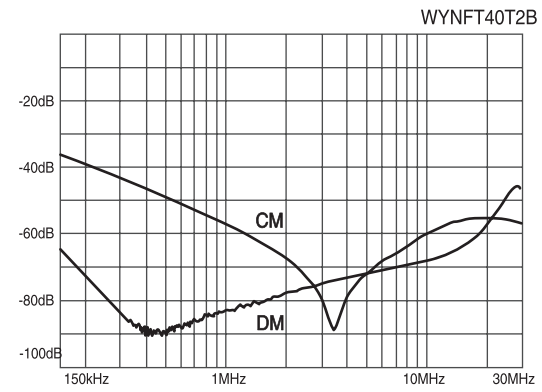
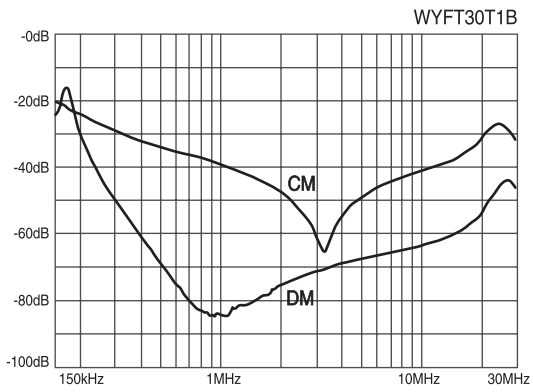
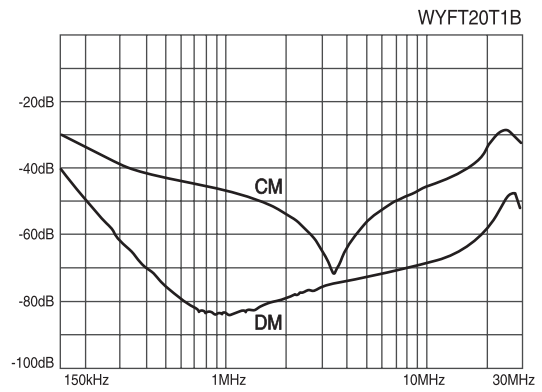
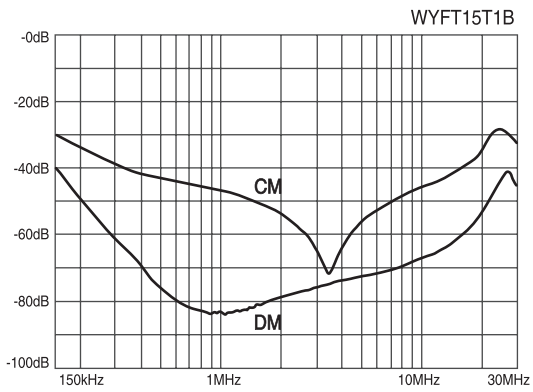
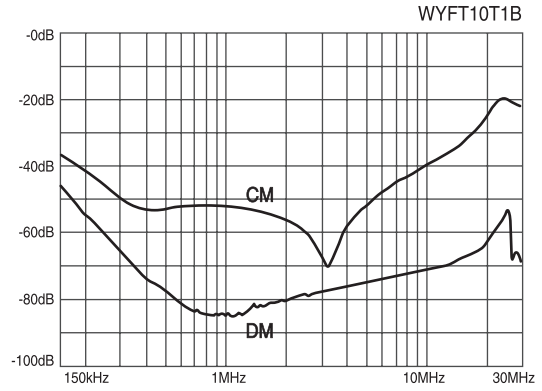
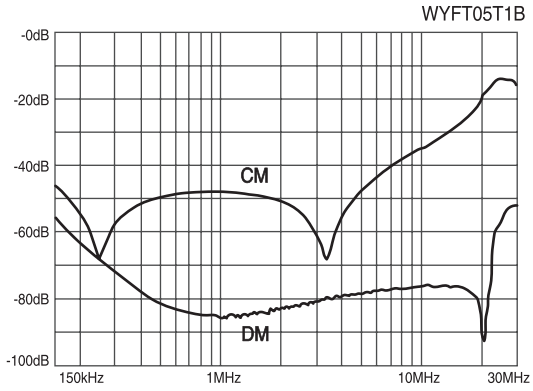

※ CM : Common mode, DM : Differential mode