

NOISE FILTER

3Ø 500V 고급형 High Quality Type



● Features

- 2 Mounting Option
 - WYF****D : Din Rail Mounting
 - WYF**** : Screw Mounting
- Wide Band : High Attenuation
- Band Width : 150KHz ~ 30MHz
- Low Leakage
- RoHS Compliant
- KC(안전인증) Approved by HK03001-19008A

● Specifications

ITEM	MODEL	SYMBOL	WYFTH05T1B (D)	WYFTH10T1B (D)	WYFTH15T1B (D)	WYFTH20T1B (D)	WYFTH30T1B (D)
Rated Voltage	V		500				
Rated Current	A		5	10	15	20	30
Frequency	Hz		50 / 60				
Dielectric Withstand	V		2500VAC for 1 minute (Line-Case)				
Insulation Resistance	MΩ		500				
Leakage Current	mA		1.2				
Operating Temperature	°C		-25°C ~ +100°C [Refer to Derating Curve TYPE-2]				
Operating Humidity	RH		35 ~ 85%RH				
Weight	kg		0.5				

※ Derating Curve of page 519

● Circuit Diagram

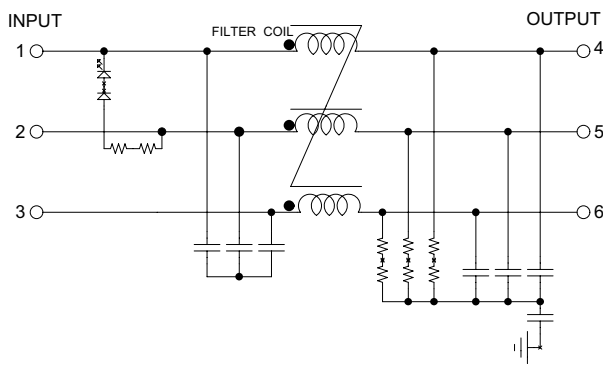

● Terminal

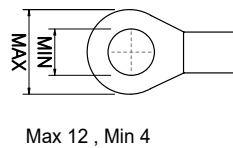

● Characteristics

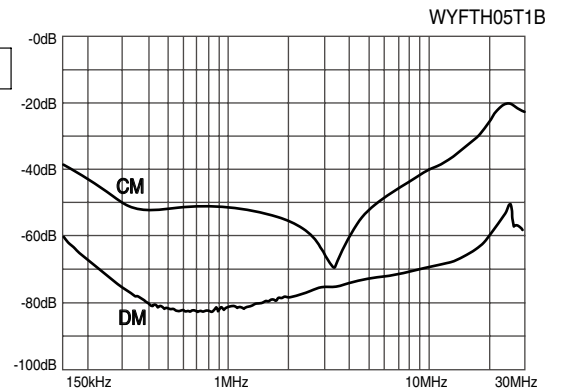

● Dimension

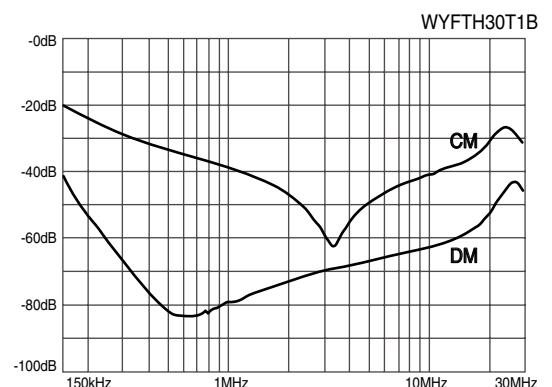
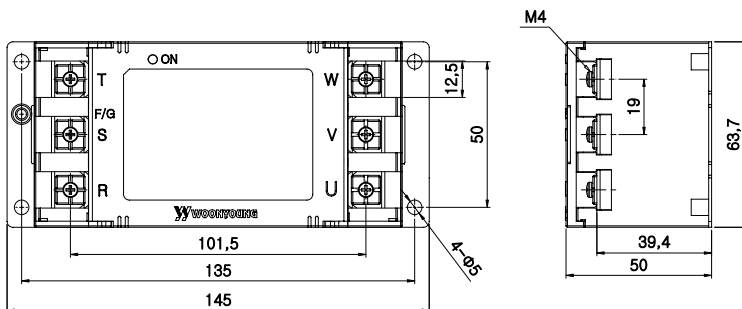

TRANS = NCT 트랜스포머
 REACTOR 리액터
 SSSR 무정전압블레이
 TPR 전력조정기
 SMPSS 스위칭파워
 NF/F 노이즈 필터
 H/F 하모닉 필터
 SPD 서지보호기
 RELAY 보호계전기
 ELD = GFR 누전경보기
 ZCT 영상변류기
 METER 판넬메타
 CT = VVT 계기용변성기
 SHUNT = FAN 션트팬

● Characteristics

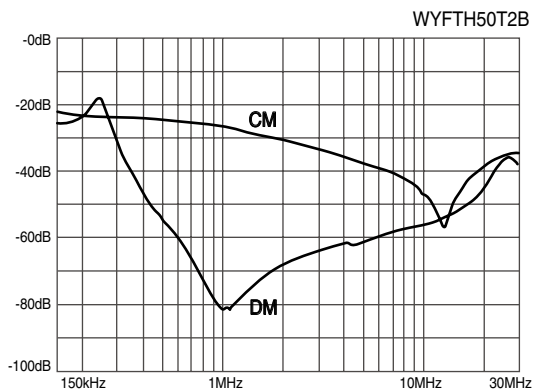
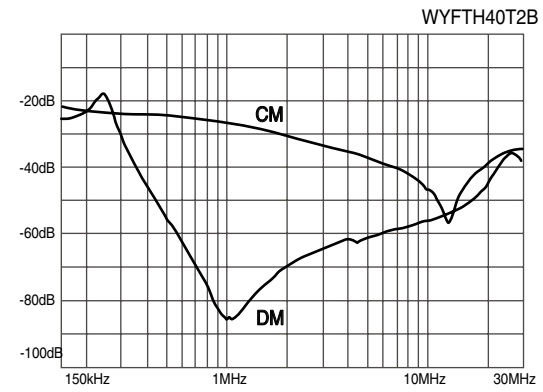
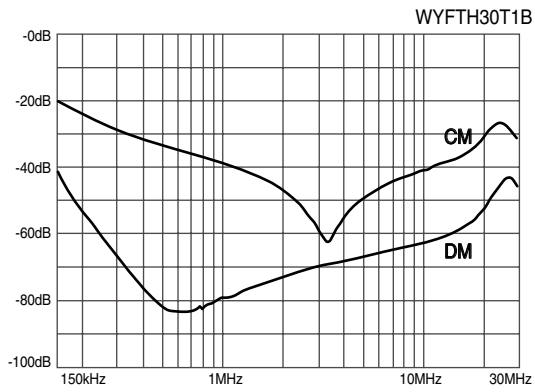
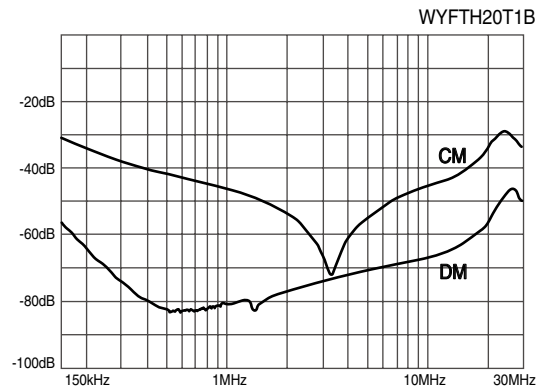
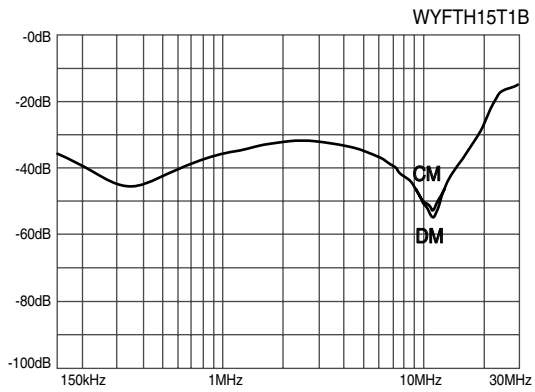
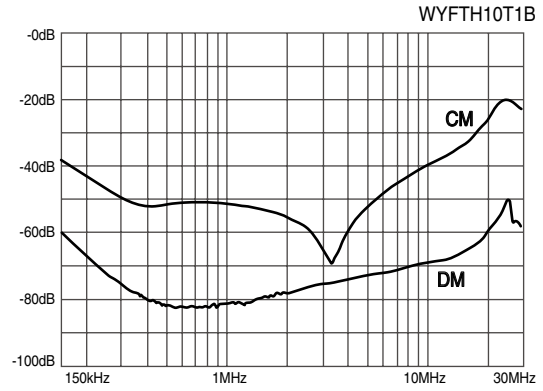
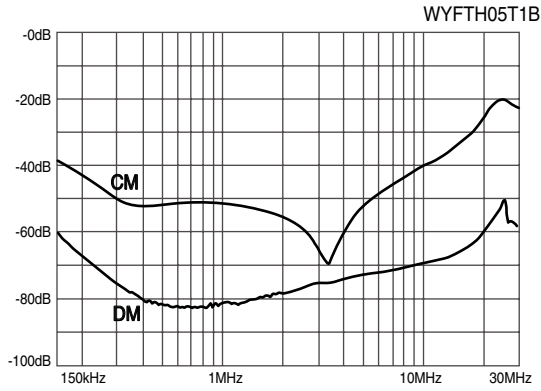

※ CM : Common mode, DM : Differential mode