

PROTECTION RELAY TYPE ZERO PHASE CURRENT TRANSFORMER

Zero Phase Sequence Current Transformer (WYZR, WYZS Type)



● 보호계전기용(200mA/1.5mA)

Model | WYZR-030N~200N (Round type) WYZS-160N~260N (Square type)

* **WY**: Manufacture mark **Z**: Zero current transformer(ZCT) **R**: Round type **S**: Square type **030**: Inside size **N**: High quality type



● Features

- 부하의 종류 및 용량에 따라 다양한 구조로 되어있습니다
- ABS 난연성 수지로 자기 소화성이 있는 재질로 되어있습니다.
- ABS 및 PC 난연성 수지로 되어 있습니다.
- Various structures by types of load and capacity
- Built-in materials with ABS flame proof resin for self-extinguish stability
- Built-in light weighted structure without using filler inside
- Terminal cover for safety

● Specifications

Item	Zero Phase Sequence Current Transformer(ZCT)			
	WYZR-030~080N	WYZR-100~120N	WYZR-150~200N	WYZS-160~260N
Type				
Rated	1st 200mA , 2nd 1.5mA (200mA/1.5mA)			
Class	±10%			
Buden	0.5VA			
Operating temperature	-10°C~+60°C			
Insulation resistance	2'th-Earth DC500V Megger 100M Ω more			
Dielectric withstand	2'th-Earth AC1,500V/1min			
Impulse withstand voltage	2'th-Earth 6kV (1,2/50 μ s) +,- 1times			

● Rating

Item	Model		Rated Current(A)	Cable(EV) mm ²			Weight (kg)
	Type	Insidedia		1P2W	1P3W 3P3W	3P4W	
 Cable through type	WYZR-030N	Ø30	100	60	14	8	0,2
	WYZR-050N	Ø50	250	150	80	38	0,2
	WYZR-065N	Ø65	400	325	150	100	0,3
	WYZR-080N	Ø80	600	400	250	200	0,4
	WYZR-100N	Ø100	800	500	325	250	0,6
	WYZR-120N	Ø120	1000	950	850	725	0,7
	WYZR-150N	Ø150	1200	1200	1000	850	1,0
 Busbar through type	WYZS-160N	166×30mm	400	6t×25mm	6t×25mm	6t×25mm	0,8
	WYZS-210N	210×30mm	500	6t×25mm	6t×25mm	6t×25mm	1,0
	WYZS-260N	260×30mm	600	8t×30mm	8t×30mm	8t×30mm	1,4

Zero Phase Sequence Current Transformer (ZCT)



● 변류기 동작 원리

누설 전류가 없는 경우에는 변류기 회로에 흐르는 전류 i_1 과 i_2 는 같고 i_1 에 의한 자속 ϕ_1 과 i_2 에 자속 ϕ_2 는 $\phi_1 = \phi_2$ 와 같이 서로 상쇄한다. 누전이 발생하면 누설 전류 i_g 가 흐르게 되어 $i_1 + i_g$ 가 되고 귀로 전류는 $i_2 + i_g$ 보다 작아져서 누설전류 i_g 에 의한 자속이 생기게 되어 영상 변류기에 유기 전압을 유도시킨다. 이 전압을 증폭해서 입력신호로 하여 릴레이를 동작시켜 경보를 발한다. 이 때 누설전류 i_g 에 의한 자속에 따른 유기전압의 식은 다음과 같다.

● The fundamental of Zero phase current transformer

The current i_1 and i_2 flowing in the current transformer circuit are the same in case of no leaked current, and the magnetic flux ϕ_1 by i_1 and ϕ_2 by i_2 are canceled out like $\phi_1 = \phi_2$. If the leakage occurs, leaked current i_g flows and it becomes $i_1 + i_g$. Then, the return current becomes smaller than $i_1 + i_g$ and magnetic flux occurs by the leaked current i_g , which induces the voltage in zero phase sequence current transformer.

The voltage is amplified and becomes the input signal for alarming by activating the relay. At this time, the equation of induced voltage of magnetic flux by leaked current i_g is shown as below.

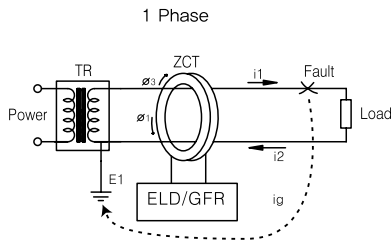

예)

3상식 아래 그림은 3상 3선식으로 부하가 일정치 않게 접속한 경우

● 누설전류가 없을시

$$i_1 = i_b - i_a, i_2 = i_c - i_b, i_3 = i_a - i_c \therefore i_1 = i_2 = i_3 = 0 \text{가 된다.}$$

● 누전 사고가 발생시

$$i_1 = i_b - i_a, i_2 = i_c - i_b, i_3 = i_a - i_c + i_g$$

$\therefore i_g = i_1 + i_2 + i_3$ 라는 누설전류가 되고 누설 전류 i_g 는 ϕ_g 라는 자속을 발생시켜 단상의 경우와 마찬가지로 영상변류기에 유기전압을 인가시켜 유기전압을 증폭하여 경보를 발하여 준다

Ex)

● In case of 3 phase The picture below of 3 phases in case of connecting irregular setting of the load

● In case of no leaked current

$$i_1 = i_b - i_a, i_2 = i_c - i_b, i_3 = i_a - i_c \therefore i_1 = i_2 = i_3 = 0$$

● In case of leakage

$$i_1 = i_b - i_a, i_2 = i_c - i_b, i_3 = i_a - i_c + i_g$$

$\therefore i_g = i_1 + i_2 + i_3$ becomes leak current. Then, leak current i_g alarms amplifying induced voltage impressing zero phase sequence current transformer same as the case of simple phase by establishing magnetic flux.

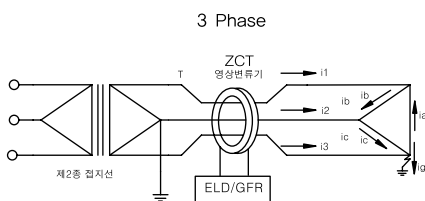

● 비접지 방식에서의 접지검출 방법

AC600V 이하의 비접지 선로에서는 접지검출이 되지 않으므로 다음과 같이 접지용 콘덴서를 이용하여 폐회로를 구성하여 주십시오.

● Grounding detection in the isolated system

Because the detection for grounding does not occur in neutral system, install the closing circuit using the grounding condenser as follows.

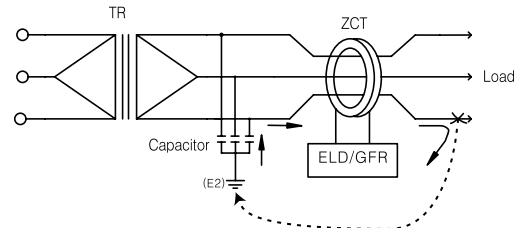

■ 콘덴서 적용 계산식 예)

Example of applying equation for condenser

$$C = \frac{2It}{2\pi fc\sqrt{3V}} \quad I_g = 2\pi fc\sqrt{3V}(A)$$

$\therefore I_t$ =Setting Value C =Condenser I_g =Fault Current

● 설치에 대한 주의사항

- 변류기(ZCT)설치시 2차 단차선은 대전력선과 10cm이상 떨어뜨려 주십시오. 또한 노이즈(고주파등)가심한 선로의 경우는 ZCT 2차선은 실-드 케이블을 사용하십시오.
- 변류기 설치시 1P3W 경우 3선모두 3P4W의 경우 4선 모두(중성선포함)를 변류기에 반드시 관통시켜 주십시오
- 영상변류기(ZCT) 바른 결선방식
※주의하여 아래 그림과 같이 반드시 결선 하십시오

● Notice for installation

- Set secondary terminal line more than 10cm apart from main power line after the ZCT setting. Also use shielding cable for secondary ZCT line in case of heavy noise (high frequency) on the line.
- Setting the zero phase sequence current transformer (ZCT), connect ZCT with all 3 lines in case of 1P3W and all 4 lines in case of 3P4W.
- Correct connection method in zero phase sequence current transformer (ZCT)
※ Ensure to connect the lines carefully as below

ZERO PHASE SEQUENCE CURRENT TRANSFORMER

Zero Phase Sequence Current Transformer (ZCT)

환형, 각형

External right connection diagram

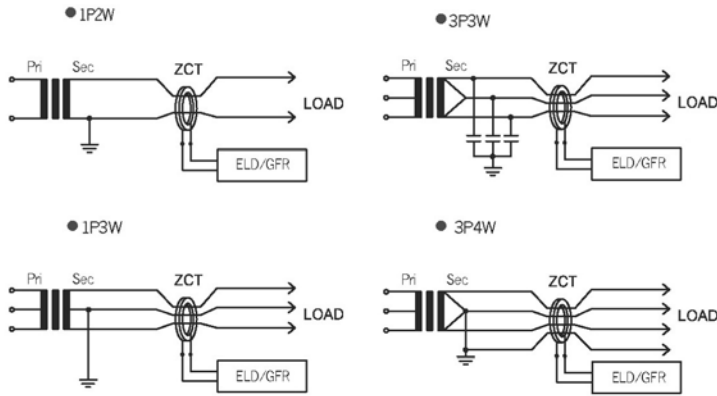

The output curve of the feature in ZCT

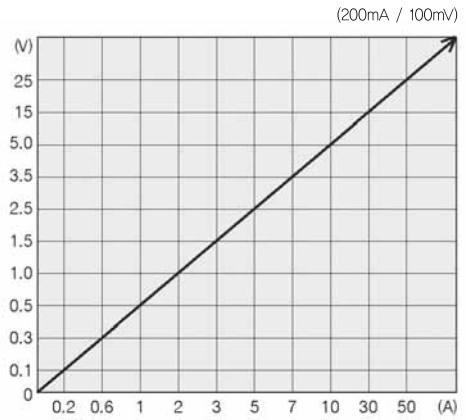

• Condition : the output voltage measured in increased current by attaching the ZCT impedance (2k Ω) to secondary ZCT

Dimension (Round type)

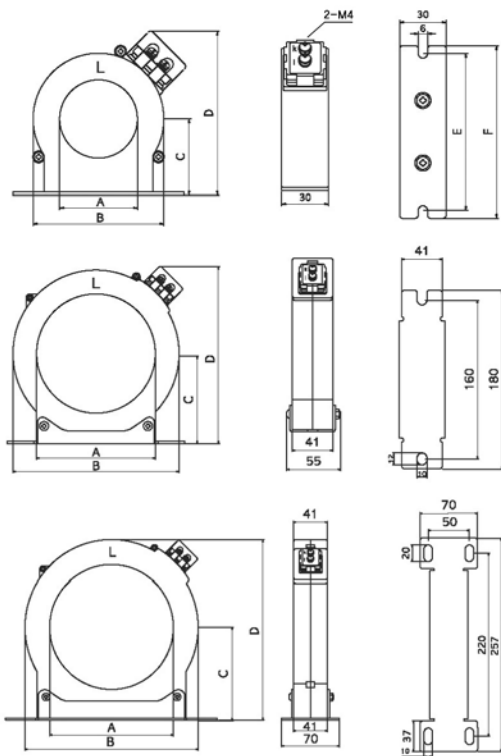

TYPE	A	B	C	D	E	F
WYZR-030	30	59	40	75	80	90
WYZR-050	50	84	48	105	100	110
WYZR-065	65	101	57	120	100	110
WYZR-080	80	120	66	136	120	130

TYPE	A	B	C	D
WYZR-100	100	140	77	155
WYZR-120	120	168	91	179

TYPE	A	B	C	D
WYZR-150	150	210	122	217
WYZR-200	200	270	142	277

Dimension (Square type)

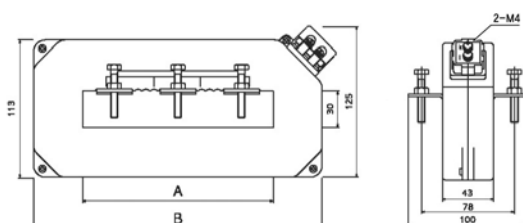

TYPE	A	B
WYZS-160	166	242
WYZS-210	210	292
WYZS-260	260	342

ZERO PHASE SEQUENCE CURRENT TRANSFORMER

Zero Phase Sequence Current Transformer (ZCT)

Bus-bar 일체형 CE

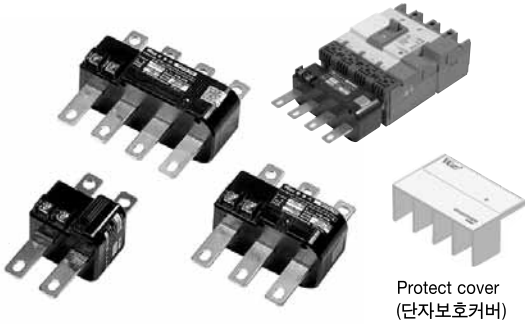

Protect cover
(단자보호커버)

● Features

- MCCB 차단기에 직접 탈부착하여 사용할 수 있는 구조
 - 1P2W, 3P3W 및 3P4W MCCB에 적용 가능
 - 취부가 간편하여 작업 시간 단축
 - PC 재질의 구조이며 자기 소화성이 있는 난연 재질임
 - 한국소방검정공사 형식승인품
 - 단자보호커버 부착으로 안전성 확보
- The structure can be used connection directly at the circuit breaker
 - It is possible to apply 3P3W and 3P4W MCCB.
 - The reduction of working hours because it is installed convenient.
 - It is the flame proof material that has the structure of PC material and self-extinguishing.
 - The formal approval products of Korea Institute of Fire Industry & Technology

● Dimension (Square type)

WYZS-102(30mm)

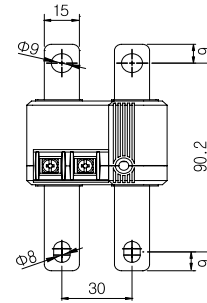
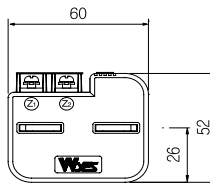
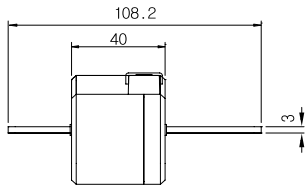

WYZS-102(35mm)

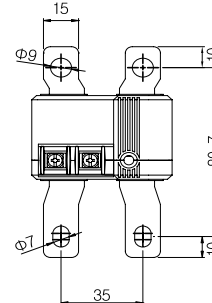
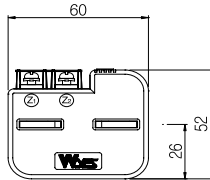
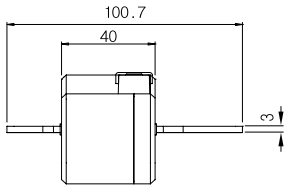

WYZS-054A

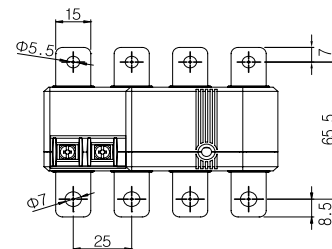
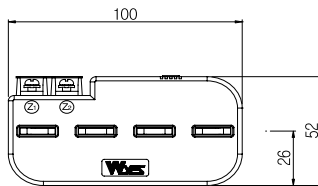
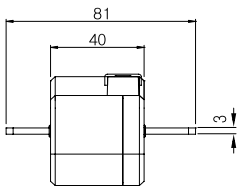

WYZS-104A

