

Surge Protective Device (SPD)

단상접지 고급형(1P2W) 220V High quality type 20/40kA series

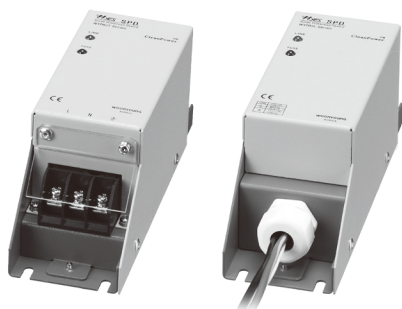
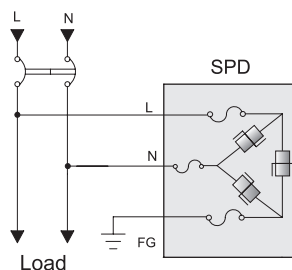

● Connection

 단상접지
(1phase earthed type)

● Specification

Item	Model	WYPB2020T220/L220	WYPB2040T220/L220
Nominal voltage (Un)		Single Phase 220VAC	
Max. continuous operating voltage (Uc)		320VAC	
Voltage protection level (Up)		(1,2kV@20kV/10kA (IEC61643-1))	
Rated frequency (Fo)		50/60Hz	
Max. discharge current (Imax)		20kA	40kA
Nominal discharge current (In)		10kA	20kA
Max. impulse current (Iimp)		-	
Protection level		Class II, III	
Protection mode		L-N, L-G, N-G	
Operating temperature range		-40~90°C	
Storage temperature range		-40~125°C	
Fuse		Thermal runaway fuse	
Connection type		T : Terminal type / L : Lead type	
Connection mode		Parallel connection type	
Wire size for connections		2.5mm ²	4mm ²
Response time		< 25 nano second	
Indicator	Green	Power	
	Red	Fuse off	
Weight (kg)		0.7	

* Model type

T : Terminal Type

L : Lead wire Type

● Dimension

- PB type -

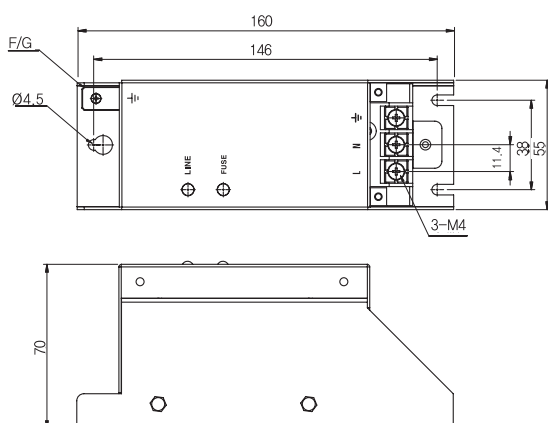

<Lead type>

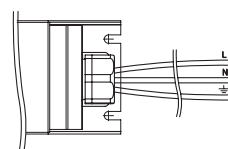
 20kA-KIV insulation wire 2.5mm²
 40kA-KIV insulation wire 4mm²

Line	Color	Lead
L	White	60cm
N	Black	60cm
⊕	Green/Yellow	1m

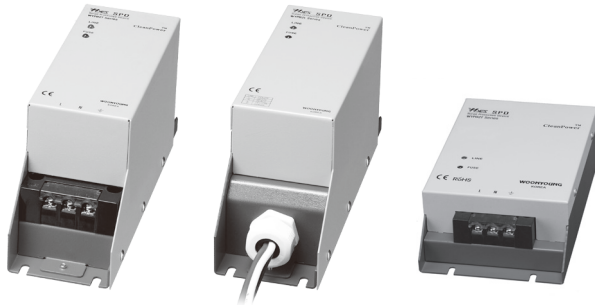

● Connection

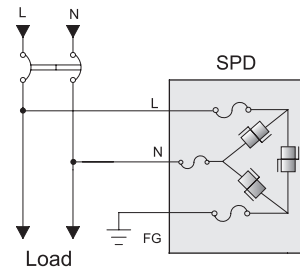

단상접지
(1phase earthed type)

● Specification

Item	Model	WYPB2080T220/L220	WYPB2100T220/L220	WYPB2120T220/L220
		WYPD2080T220/L220	WYPD2100T220/L220	WYPD2120T220/L220
Nominal voltage (Un)		Single phase 220VAC		
Max. continuous operating voltage (Uc)		320VAC		
Voltage protection level (Up)		(1.2kV@20kV/10kA (IEC61643-1))		
Rated frequency (Fo)		50/60Hz		
Max. discharge current (Imax)		80kA	100kA	120kA
Nominal discharge current (In)		40kA	50kA	60kA
Max. impulse current (Iimp)		-		
Protection level		Class II, III		
Protection mode		L-N, L-G, N-G		
Operating temperature range		-40~90°C		
Storage temperature range		-40~125°C		
Fuse		Thermal runaway fuse		
Connection type		T : Terminal type / L : Lead type		
Connection mode		Parallel connection type		
Wire size for connections		6mm ²		10mm ²
Response time		< 25 nano second		
Indicator	Green	Power		
	Red	Fuse off		
Weight (kg)		1.8		

* Model type
T : Terminal Type
L : Lead wire Type

● Dimension

- PB type -

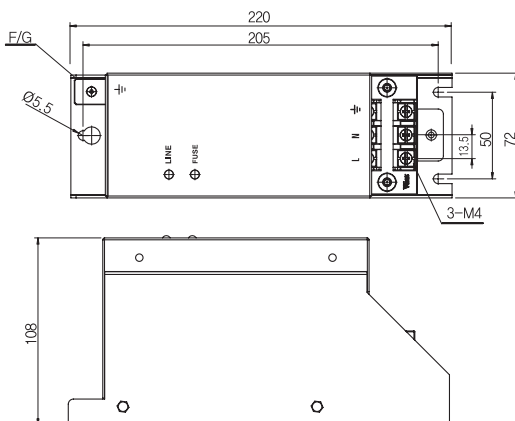

- PD type -

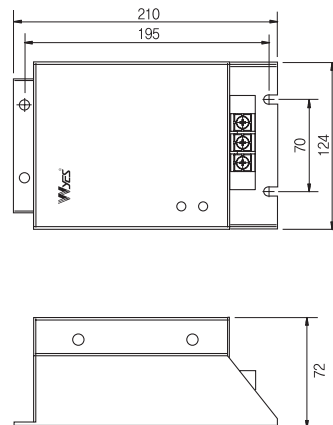

<Lead type>

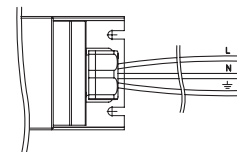

80/100kA-KIV insulation wire 6mm²
120kA-KIV insulation wire 10mm²

Line	Color	Lead
L	White	60cm
N	Black	60cm
FG	Green/Yellow	1m

T
R
A
N
S
트랜스포머

N
C
T
노이즈컷트랜스

S
S
R
무선전압레일

T
P
R
전력조정기

S
M
P
스미칭파워

N
/
F
노이즈필터

H
/
F
고조파필터

S
P
D
서지보호기

R
E
L
A
Y
보호계전기

E
L
D
누전경보기

G
F
R
지락계전기

Z
C
T
영상변류기

M
E
T
E
R
지시전기계기

C
T
/
V
T
계기용변성기

F
A
N
팬

Surge Protective Device (SPD)

단상접지 고급형(1P2W) 380, 440V High quality type 20/40kA series

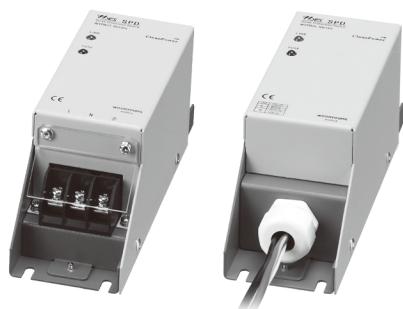

● Connection

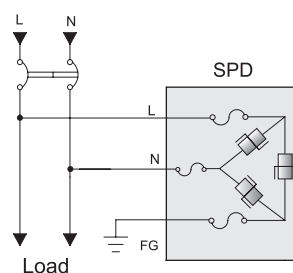

단상접지
(1phase earthed type)

● Specification

Item	Model	WYPB2020T380/L380	WYPB2040T380/L380
		WYPB2020T440/L440	WYPB2040T440/L440
Nominal voltage (Un)		Single phase 380, 440VAC	
Max. continuous operating voltage (Uc)		460/625VAC	
Voltage protection level (Up)		(1.2kV@20kV/10kA (IEC61643-1))	
Rated frequency (Fo)		50/60Hz	
Max. discharge current (Imax)		20kA	40kA
Nominal discharge current (In)		10kA	20kA
Max. impulse current (Iimp)		-	
Protection level		Class II, III	
Protection mode		L-N, L-G, N-G	
Operating temperature range		-40~90°C	
Storage temperature range		-40~125°C	
fuse		Thermal runaway fuse	
Connection type		T : Terminal type / L : Lead type	
Connection mode		Parallel connection type	
Wire size for connections		2.5mm ²	4mm ²
Response time		< 25 nano second	
Indicator	Green	Power	
	Red	Fuse off	
Weight (kg)		0.7	

* Model type

T : Terminal Type

L : Lead wire Type

● Dimension

- PB type -

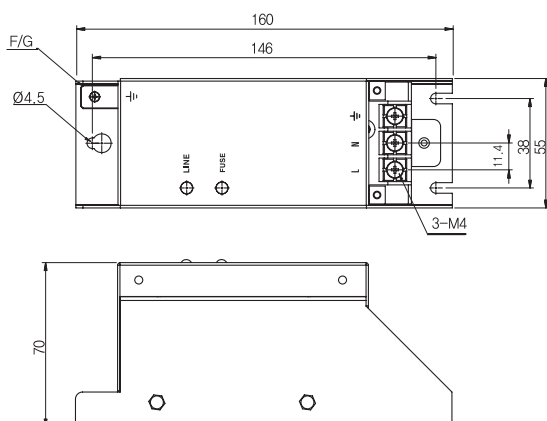

<Lead type>

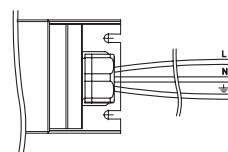

20kA-KIV insulation wire 2.5mm²
40kA-KIV insulation wire 4mm²

Line	Color	Lead
L	White	60cm
N	Black	60cm
⊥	Green/Yellow	1m

Surge Protective Device (SPD)

단상접지 고급형(1P2W) 380, 440V High quality type 80/100/120kA series

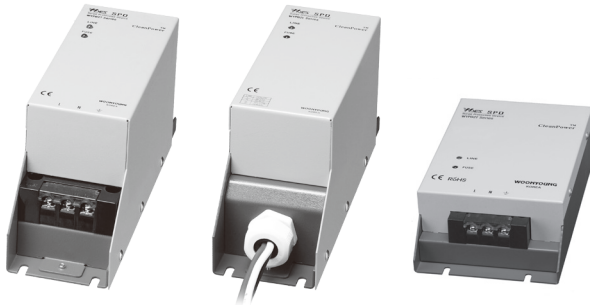

● Connection

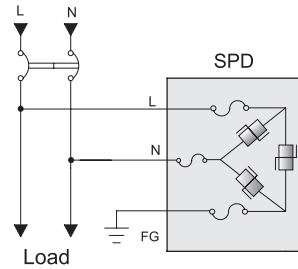

단상접지 (1phase earthed type)

● Specification

Item	Model	WYPB2080T380/L380 WYPB2080T440/L440	WYPB2100T380/L380 WYPB2100T440/L440	WYPB2120T380/L380 WYPB2120T440/L440
		WYPD2080T380/L380 WYPD2080T440/L440	WYPD2100T380/L380 WYPD2100T440/L440	WYPD2120T380/L380 WYPD2120T440/L440
Nominal voltage (Un)	Single phase 380, 440VAC			
Max. continuous operating voltage (Uc)	460/625VAC			
Voltage protection level (Up)	(1.2kV@20kV/10kA (IEC61643-1))			
Rated frequency (Fo)	50/60Hz			
Max. discharge current (Imax)	80kA	100kA	120kA	
Nominal discharge current (In)	40kA	50kA	60kA	
Max. impulse current (Iimp)	-			
Protection level	Class II, III			
Protection mode	L-N, L-G, N-G			
Operating temperature range	-40~90°C			
Storage temperature range	-40~125°C			
Fuse	Thermal runaway fuse			
Connection type	T : Terminal type / L : Lead type			
Connection mode	Parallel connection type			
Wire size for connections	6mm ²		10mm ²	
Response time	< 25 nano second			
Indicator	Green	Power		
	Red	Fuse off		
Weight (kg)	1.8			

* Model type
T : Terminal Type
L : Lead wire Type

● Dimension

- PB type -

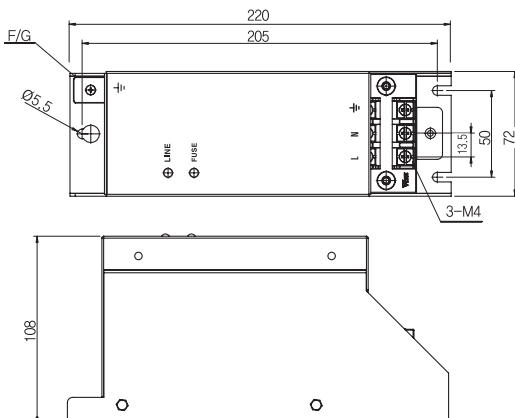

- PD type -

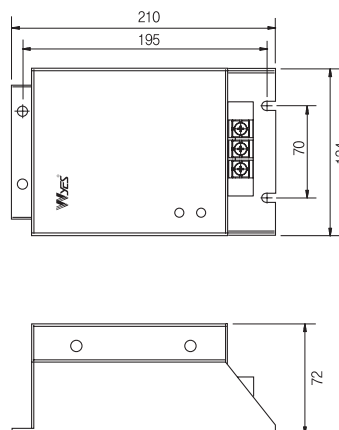

<Lead type>

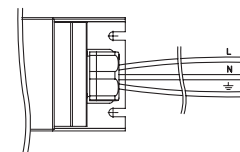

80/100kA-KIV insulation wire 6mm²
120kA-KIV insulation wire 10mm²

Line	Color	Lead
L	White	60cm
N	Black	60cm
⊕	Green/Yellow	1m

트랜스포머
노이즈컷트랜스
무선전압릴레이
전력조정기
스마트파워
노이즈필터
고조파필터
서지보호기
보호계전기
누전경보기
자량계전기
영상변류기
지시전기계기
계기용변성기
FAN

Surge Protective Device (SPD)

삼상접지 고급형(3P3W) 220V High quality type 20/40kA series

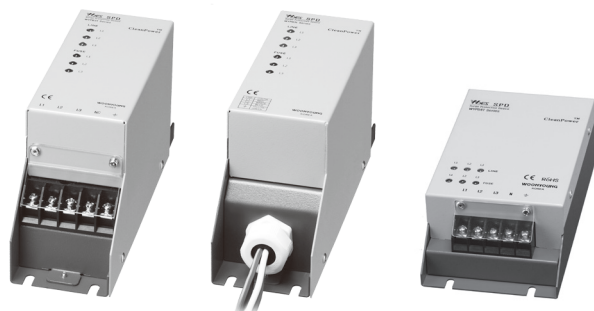

● Connection

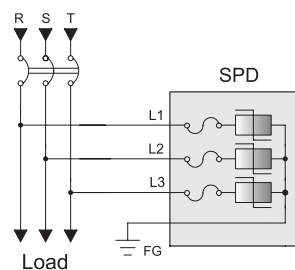

삼상접지
(3phase earthed type)

● Specification

Item	Model	WYPB3020T220/L220	WYPB3040T220/L220
		WYPD3020T220/L220	WYPD3040T220/L220
Nominal voltage (Un)		Three phase 220VAC	
Max. continuous operating voltage (Uc)		320VAC	
Voltage protection level (Up)		(2,1kV@20kV/10kA (IEC61643-1))	
Rated frequency (Fo)		50/60Hz	
Max. discharge current (Imax)		20kA	40kA
Nominal discharge current (In)		10kA	20kA
Max. impulse current (Iimp)		-	
Protection level		Class II, III	
Protection mode		L-L, L-G	
Operating temperature range		-40~90°C	
Storage temperature range		-40~125°C	
Fuse		Thermal runaway fuse	
Connection type		T : Terminal type / L : Lead type	
Connection mode		Parallel connection type	
Wire size for connections		2,5mm ²	4mm ²
Response time		< 25 nano second	
Indicator	Green	Power	
	Red	Fuse off	
Weight (kg)		1,1	

* Model type

T : Terminal Type
L : Lead wire Type

● Dimension

- PB type -

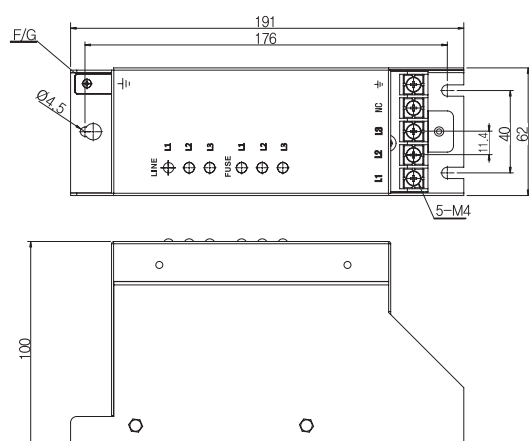

- PD type -

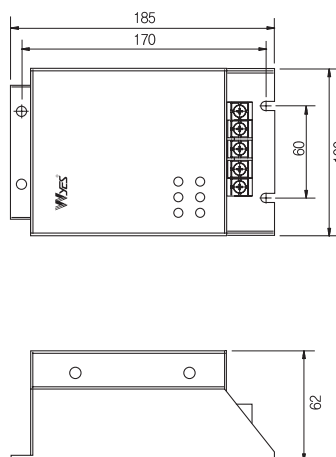

<Lead type>

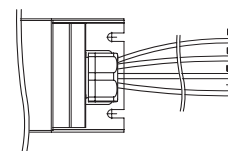

20kA-KIV insulation wire 2.5mm²
40kA-KIV insulation wire 4mm²

Line	Color	Lead
L1	Red	60cm
L2	White	60cm
L3	Blue	60cm
⊥	Green/Yellow	1m

Surge Protective Device (SPD)

삼상접지 고급형(3P3W) 220V High quality type 80~240kA series



● Connection

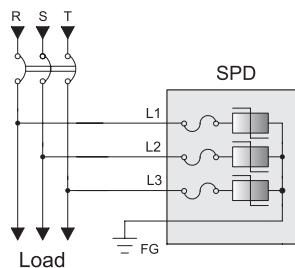

삼상접지
(3phase earthed type)

● Specification

Item	Model	WYPB3080T220/L220	WYPB3100T220/L220	WYPB3120T220/L220	WYPB3160T220/L220	WYPB3200T220/L220	WYPB3240T220/L220
		WYPD3080T220/L220	WYPD3100T220/L220	WYPD3120T220/L220	WYPD3160T220/L220	WYPD3200T220/L220	WYPD3240T220/L220
Nominal voltage (Un)	Three phase 220VAC						
Max. continuous operating voltage (Uc)	320VAC						
Voltage protection level (Up)	〈 2.1kV@20kV/10kA (IEC61643-1) 〉						
Rated frequency (Fo)	50/60Hz						
Max. discharge current (Imax)	80kA	100kA	120kA	160kA	200kA	240kA	
Nominal discharge current (In)	40kA	50kA	60kA	80kA	100kA	120kA	
Max. impulse current (Iimp)	-					12,5kA	
Protection level	Class II, III					Class I, II, III	
Protection mode	L-L, L-G						
Operating temperature range	-40~90°C						
Storage temperature range	-40~125°C						
Fuse	Thermal runaway fuse						
Connection type	T : Terminal type / L : Lead type						
Connection mode	Parallel connection type						
Wire size for connections	6mm ²			10mm ²			
Response time	〈 25 nano second 〉						
Indicator	Green	Power					
	Red	Fuse off					
Weight (kg)	2,3						

* Model type

T : Terminal Type
L : Lead wire Type

● Dimension

- PB type -

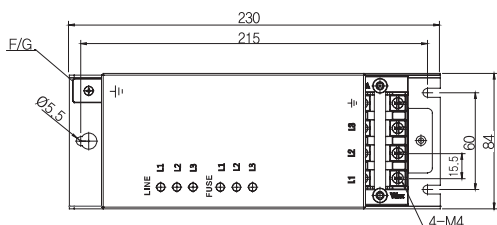

- PD type -

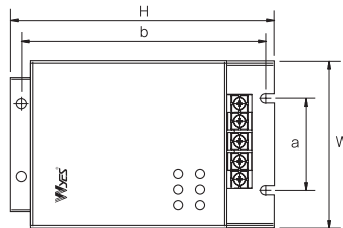

<Lead type>

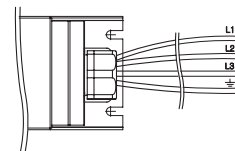

80/100kA-KIV insulation wire 6mm²
120/160/200/240kA-KIV insulation wire 10mm²

Line	Color	Lead
L1	Red	60cm
L2	White	60cm
L3	Blue	60cm
FG	Green/Yellow	1m

Type	W	H	D	a	b
80~100kA	120	190	70	70	175
120~240kA	135	230	84	70	215

TRANS

NOCT

SSR

TPR

SMP

N/F

H/F

SPD

RELA

ELD

GFR

ZCT

METER

CT/VT

FAN

Surge Protective Device (SPD)

삼상접지 고급형(3P3W) 380, 440V High quality type 20/40kA series

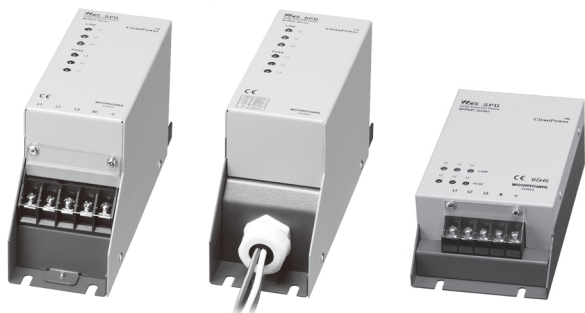

● Connection

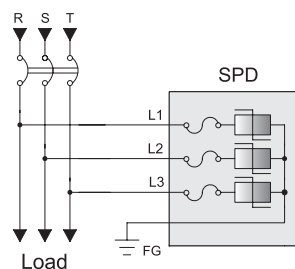

삼상접지
(3phase earthed type)

● Specification

Item	Model	WYPB3020T380/L380 WYPB3020T440/L440	WYPB3040T380/L380 WYPB3040T440/L440
		WYPD3020T380/L380 WYPD3020T440/L440	WYPD3040T380/L380 WYPD3040T440/L440
Nominal voltage (Un)	Three phase 380, 440VAC		
Max. continuous operating voltage (Uc)	460/625VAC		
Voltage protection level (Up)	〈 2.1kV@20kV/10kA (IEC61643-1) 〉		
Rated frequency (Fo)	50/60Hz		
Max. discharge current (Imax)	20kA	40kA	
Nominal discharge current (In)	10kA	20kA	
Max. impulse current (Iimp)	-		
Protection level	Class II, III		
Protection mode	L-L, L-G		
Operating temperature range	-40~90°C		
Storage temperature range	-40~125°C		
Fuse	Thermal runaway fuse		
Connection type	T : Terminal type / L : Lead type		
Connection mode	Parallel connection type		
Wire size for connections	2.5mm ²	4mm ²	
Response time	〈 25 nano second 〉		
Indicator	Green	Power	
	Red	Fuse off	
Weight (kg)	1.1		

* Model type

T : Terminal Type

L : Lead wire Type

● Dimension

- PB type -

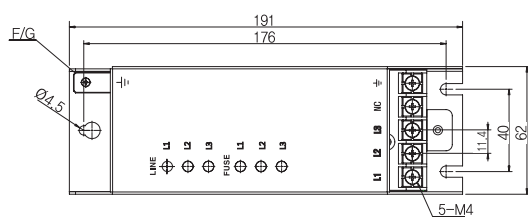

- PD type -

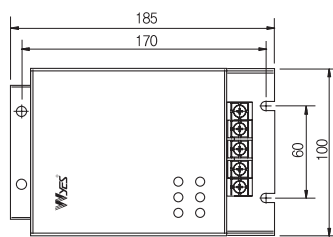

<Lead type>

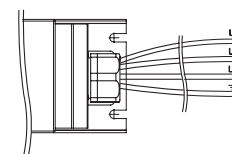

20kA-KIV insulation wire 2.5mm²
40kA-KIV insulation wire 4mm²

Line	Color	Lead
L1	Red	60cm
L2	White	60cm
L3	Blue	60cm
⊥	Green/Yellow	1m

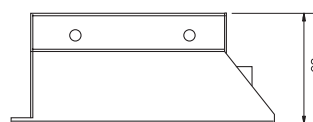
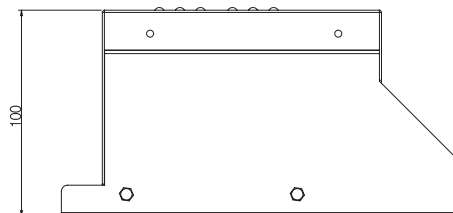

Surge Protective Device (SPD)

서지 낙뢰 보호기

삼상접지 고급형(3P3W) 380, 440V High quality type 80~240kA series



● Connection

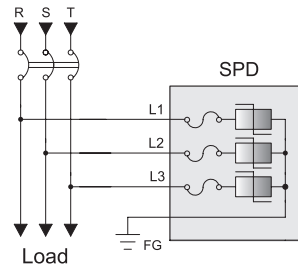

삼상접지
(3phase earthed type)

● Specification

Item	Model	WYPB3080T380/L380	WYPB3100T380/L380	WYPB3120T380/L380	WYPB3160T380/L380	WYPB3200T380/L380	WYPB3240T380/L380
		WYPB3080T440/L440	WYPB3100T440/L440	WYPB3120T440/L440	WYPB3160T440/L440	WYPB3200T440/L440	WYPB3240T440/L440
Nominal voltage (Un)	Three phase 380, 440VAC						
Max. continuous operating voltage (Uc)	460/625VAC						
Voltage protection level (Up)	(2.1kV@20kV/10kA (IEC61643-1)						
Rated frequency (Fo)	50/60Hz						
Max. discharge current (Imax)	80kA	100kA	120kA	160kA	200kA	240kA	
Nominal discharge current (In)	40kA	50kA	60kA	80kA	100kA	120kA	
Max. impulse current (Iimp)	-					12.5kA	
Protection level	Class II, III					Class I, II, III	
Protection mode	L-L, L-G						
Operating temperature range	-40~90°C						
Storage temperature range	-40~125°C						
Fuse	Thermal runaway fuse						
Connection type	T : Terminal type / L : Lead type						
Connection mode	Parallel connection type						
Wire size for connections	6mm ²			10mm ²			
Response time	< 25 nano second						
Indicator	Green	Power					
	Red	Fuse off					
Weight (kg)	2.3						

* Model type
T : Terminal type
L : Lead wire Type

● Dimension

- PB type -

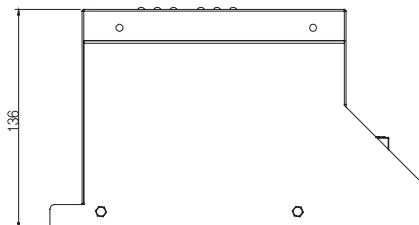
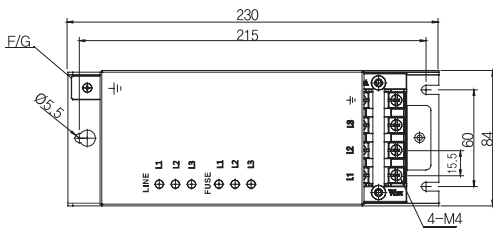

- PD type -

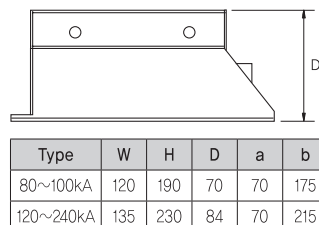
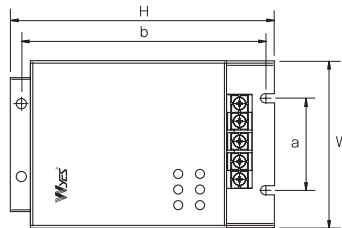

<Lead type>

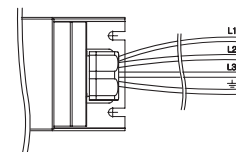

80/100kA-KIV insulation wire 6mm²
120/160/200/240kA-KIV insulation wire 10mm²

Line	Color	Lead
L1	Red	60cm
L2	White	60cm
L3	Blue	60cm
⊥	Green/Yellow	1m

T
R
A
N
S
포머
노
이즈
컷트
트
랜
스
무
연
접
합
레
이
전
력
조
정
기
스
미
칭
파
워
노
이즈
필
터
고
조
파
필
터
서
지
보
호
기
보
호
계
전
기
누
전
경
보
기
자
랑
계
전
기
영
상
변
류
기
지
시
전
기
계
기
용
변
성
기
팬

Surge Protective Device (SPD)

삼상N접지 고급형(3P4W) 380/220V High quality type 20/40kA series

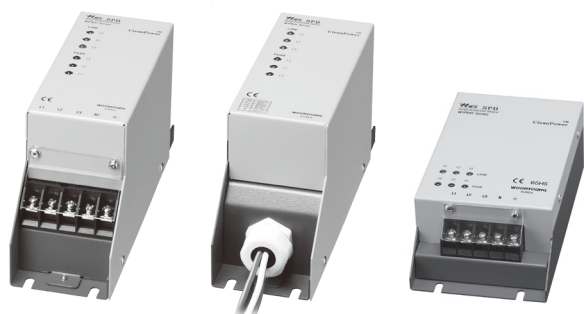

● Connection

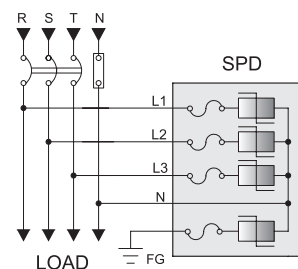

삼상N접지
(3phase N-earthed type)

● Specification

Item	Model	WYPB4020T380/L380	WYPB4040T380/L380
		WYPD4020T380/L380	WYPD4040T380/L380
Nominal voltage (Un)		Three phase 380/220VAC	
Max. continuous operating voltage (Uc)		320/640VAC	
Voltage protection level (Up)	L-N, N-G	〈 1,2kV@20kV/10kA (IEC61643-1) 〉	
	L-L, L-G	〈 2,1kV@20kV/10kA (IEC61643-1) 〉	
Rated frequency (Fo)		50/60Hz	
Max. discharge current (Imax)		20kA	40kA
Nominal discharge current (In)		10kA	20kA
Max. impulse current (Iimp)		-	
Protection level		Class II, III	
Protection mode		L-L, L-G	
Operating temperature range		-40~90℃	
Storage temperature range		-40~125℃	
Fuse		Thermal runaway fuse	
Connection type		T : Terminal type / L : Lead type	
Connection mode		Parallel connection type	
Wire size for connections		2,5mm ²	4mm ²
Response time		〈 25 nano second 〉	
Indicator	Green	Power	
	Red	Fuse off	
Weight (kg)		1,1	

* Model type

T : Terminal Type

L : Lead wire Type

● Dimension

- PB type -

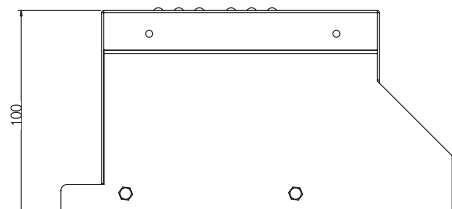
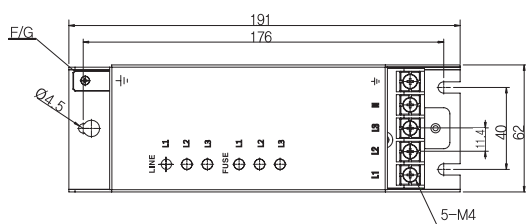

- PD type -

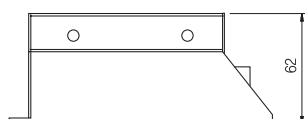
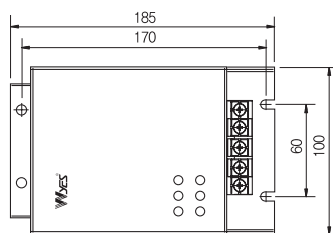

<Lead type>

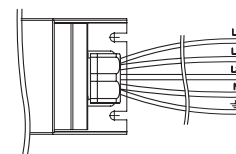

20kA-KIV insulation wire 2.5mm²
40kA-KIV insulation wire 4mm²

Line	Color	Color
L1	Red	60cm
L2	White	60cm
L3	Blue	60cm
N	Black	60cm
FG	Green/Yellow	1m



● Connection

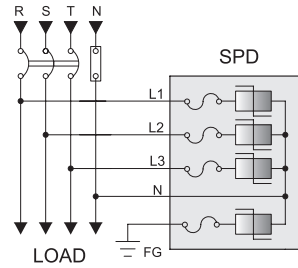

삼상N접지
(3phase N-earthed type)

● Specification

Item	Model	WYPB4080T380/L380 WYPD4080T380/L380	WYPB4100T380/L380 WYPD4100T380/L380	WYPB4120T380/L380 WYPD4120T380/L380	WYPB4160T380/L380 WYPD4160T380/L380	WYPB4200T380/L380 WYPD4200T380/L380	WYPB4240T380/L380 WYPD4240T380/L380
Nominal voltage (Un)	Three phase 380/220VAC						
Max. continuous operating voltage (Uc)	320/640VAC						
Voltage protection level (Up)	L-N, N-G	1.2kV@20kV/10kA (IEC61643-1)					
	L-L, L-G	2.1kV@20kV/10kA (IEC61643-1)					
Rated frequency (Fo)	50/60Hz						
Max. discharge current (Imax)	80kA	100kA	120kA	160kA	200kA	240kA	
Nominal discharge current (In)	40kA	50kA	60kA	80kA	100kA	120kA	
Max. impulse current (Iimp)	-					12.5kA	
Protection level	Class II, III					Class I, II, III	
Protection mode	L-L, L-G						
Operating temperature range	-40~90°C						
Storage temperature range	-40~125°C						
Fuse	Thermal runaway fuse						
Connection type	T : Terminal type / L : Lead type						
Connection mode	Parallel connection type						
Wire size for connections	6mm ²			10mm ²			
Response time	< 25 nano second						
Indicator	Green	Power					
	Red	Fuse off					
Weight (kg)							

* Model type
T : Terminal Type
L : Lead wire Type

● Dimension

- PB type -

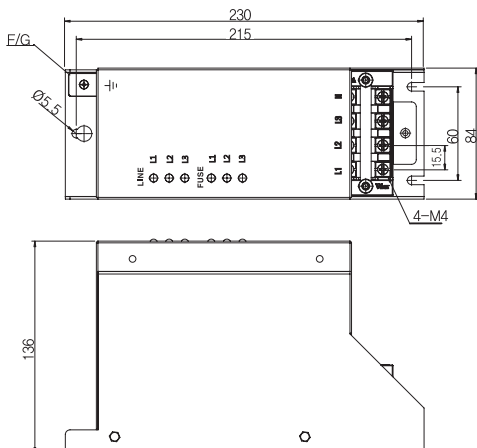

- PD type -

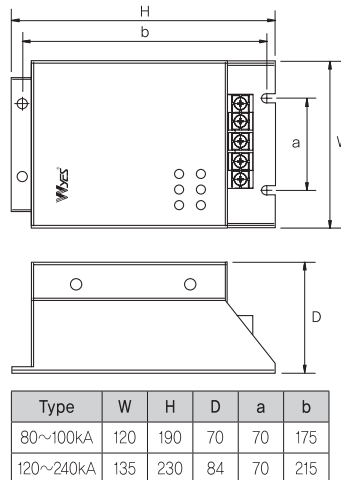

<Lead type>

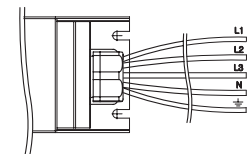

80/100kA-KIV insulation wire 6mm²
120/160/200/240kA-KIV insulation wire 10mm²

Line	Color	Color
L1	Red	60cm
L2	White	60cm
L3	Blue	60cm
N	Black	60cm
FG	Green/Yellow	1m